

THERMOROSSI

Fire Lovers



- Pellet Home Collection -

Fire Lovers
THERMOROSI

- Pellet Home Collection -



Since 1968



To present

- ITA** Sorta in una provincia ricca di tradizione metalmeccanica e aperta alle più innovative tecnologie, Thermorossi opera con successo da oltre 45 anni nel settore dei riscaldamento fino a diventare, oggi, una tra le più affermate ed avanzate industrie europee nella produzione di stufe, termocucine e caldaie.
- DEU** Seit 45 Jahren arbeitet Thermorossi in der Heizungsbranche mit Erfolg und zählt heute als einer der namhaftesten und innovativsten Hersteller von Kaminöfen, Zentralheizungskoch-herden und Heizkesseln in Europa.
- ENG** Established in a province renowned for its metalworking traditions and open to modern technology, Thermorossi has been working with success in the heating sector for 45 years and is now one of the leading and advanced European companies in the production of stoves, central heating cookers and boilers.
- FRA** Installé depuis plus de 45 ans dans une région riche en tradition mécanique et métallurgique ouverte aux technologies les plus avancées, Thermorossi est un des leaders européens dans la production de poêles, inserts, thermo-cuisinières et chaudières, à bûches et à granulés.
- ESP** Establecida en una provincia renombrada por su tradición metalúrgica y abierta a las tecnologías más modernas, Thermorossi trabaja con éxito en el sector de la calefacción desde hace 45 años y ahora es una de las empresas europeas principales y más avanzadas en la producción de estufas, cocinas de calefacción central y calderas de leña.





Ogni apparecchio viene acceso in fabbrica e verificato per almeno 1 ora di funzionamento

Jeder Ofen wurde schon im Werk eine Stunde beheizt und eingestellt

Every unit is tested for 1 hour in the factory

Chaque appareil est allumé en usine et contrôlé pendant au moins 1 heure de fonctionnement

Cada equipo se ha probado y testado en fábrica durante una hora

Telecomando in dotazione

Fernbedienung im Lieferumfang enthalten

Remote control included

Doté de télécommande de série

Mando a distancia incluido

I nostri prodotti non necessitano di ulteriori costi per tarature e collaudi. Nel caso il pellet ENplus fosse di qualità diversa esistono diversi programmi di funzionamento selezionabili

Unsere Produkte müssen nicht nach der Installation speziell eingestellt und kontrolliert werden, denn, wenn die Pelletqualität variiert, kann das System per Tastendruck darauf einfach und simpel angepasst werden

Our products don't incur additional costs for adjustments or testing. In case of pellet fuel of lower quality than En plus standards, it is possible to select different operation programs and set up

Nos produits ne nécessitent d'aucuns coûts de tarage ou d'essais. Au cas où les granulés soient de qualité différente de Enplus, nos produits disposent de divers programmes de fonctionnement

Nuestros productos no necesitan de más costes por ajustes o pruebas. En el caso que el combustible sea de calidad distinta a ENplus existen programas de operación opcionales

Easy Cleaning



Il grande cassetto cenere e le adeguate ispezioni per la pulizia semplificano la manutenzione mantenendo l'efficienza ai massimi livelli

Der große Ascheauffang sowie die leicht zugänglichen Reinigungsöffnungen machen die Reinigung des Gerätes viel einfacher und komfortabler, wodurch die Effizienz des Gerätes hoch gehalten wird

The wide ash pan and the obvious inspection points make maintenance easier keeping the efficiency at highest levels. Simple periodic maintenance

Le grand tiroir des cendres et les inspections de nettoyage pratiques simplifient l'entretien, gardant le rendement au plus haut niveau. Aucune surprise durant l'entretien périodique

El ancho cajón de ceniza y una inspección de limpieza cómoda simplifican la mantención manteniendo el rendimiento a máximos niveles y evitando sorpresas

Il fascio tubiero verticale e l'elevato numero di elementi formano il sistema Thermocore®. Il sistema incrementa la superficie di scambio e migliora il rendimento termico

Der vertikale Rohrwärmetauscher mit großer Wärmetauscherfläche ist das Herzstück des Thermocore® Systems. Dieses System steigert die Wärmetauscherfläche und erhöht den Wirkungsgrad

The vertical pipes heat exchanger and the high number of exchange elements form the Thermocore® system. This system increases the exchange surface and improve thermal efficiency

Le faisceau tubulaire vertical et ses nombreux éléments forment le système Thermocore®, qui augmente la superficie d'échange de chaleur et améliore le rendement thermique

El intercambiador turbolador vertical de muchos elementos crea el sistema Thermocore®. Este sistema aumenta la superficie de intercambio y mejora el rendimiento térmico

Il ventilatore ambiente, con rotore esterno, è garantito 4 anni perché ermetico alla polvere

4 Jahre Garantie auf den hermetisch dichten Raumluftventilator

External rotor room fan is guaranteed for 4 years being hermetic to dust

Le ventilateur d'air ambiant, avec son moteur à rotor externe, est garanti 4 ans parce qu'hermétique à la poussière

El ventilador ambiente con motor rotor externo lleva 4 años de garantía al ser ermetico al polvo

Funzione «crono» per programmazione settimanale (tre accensioni e tre spegnimenti al giorno)

"Chrono" function for weekly timing program (three daily Starts)

Fonction « Chrono » pour la programmation hebdomadaire (trois allumages et extinctions par jour)

Our products produce only 36 decibels of noise at minimum level of operation

Rigidi criteri costruttivi, elevati spessori della materia prima impiegata, offrono un grande accumulo termico e durata dei componenti

Hohe Produktionsstandards, hohe Qualität der Rohstoffe, garantieren lange Lebensdauer aller feuerberührten Teile und des Brenners

The strict manufacturing standards, the high quality of raw materials, grant higher heat accumulation, stable durability of the burning pot and other components

Les critères de construction rigides, les grosses épaisseurs des matériaux utilisés, offrent une grande capacité d'accumulation thermique, de stabilité dimensionnelle du brûleur, et de durée des composants

Nuestros equipos son el resultado de exigentes criterios de construcción. Ofrecemos equipos con una gran acumulación térmica, estabilidad dimensional del quemador y durabilidad de los componentes

I nostri prodotti a regime minimo misurano solo 36 decibel di fruscio durante il funzionamento

Unsere Produkte emittieren nur 36 Dezibel bei kleinster Heizleistung

Our products produce only 36 decibels of noise at minimum level of operation

Au régime minimum de fonctionnement, nos produits émettent seulement 36 décibels de bruit

Nuestros equipos trabajan a niveles mínimos de sonido. Solamente miden 36 decibelios de sonoridad a nivel mínimo de operación

Per tutti coloro che pretendono la comodità delle stufe a pellet ma non vogliono un sistema di ventilazione forzata, Thermorossi propone una ampia gamma di stufe a convezione naturale

Für Kunden, die nicht auf einen Pelletofen verzichten wollen aber keinen Raumluftventilator wünschen, bietet Thermorossi eine Auswahl an verschiedenen Öfen mit Strahlungs- und Konvektionswärme an

For those who want the convenience of pellet stoves, but not fan ventilation; Thermorossi offers a wide range of convection stoves

Pour tous ceux qui prétendent la commodité des poêles à granulés, mais ne veulent pas de système de ventilation forcée, Thermorossi propose une ample gamme de poêles à convection naturelle

Para los que exigen la conveniencia de las estufas de pellets, pero no quieren un sistema de ventilación forzada, Thermorossi ofrece una amplia gama de estufas de convección natural

Made in Italy: Thermorossi si avvale delle più moderne tecniche di produzione e tutti i prodotti sono conformi alle più severe normative europee
 Made in Italy: Thermorossi benutzt die neuesten Fertigungsmethoden und alle Geräte erfüllen die strengsten Anforderungen der Europäischen Richtlinien bezüglich Sicherheit und Umweltschutz
 Made in Italy: Thermorossi uses the most modern techniques of production and all products conform to the strictest European regulations.
 Made in Italy: Thermorossi se sert des techniques de production les plus performantes et tous les produits sont conformes aux normes européennes les plus sévères
 Made in Italy: Thermorossi utiliza las técnicas más modernas de producción y todos los productos se ajustan a las más estrictas normas europeas





E' possibile regolare il livello di ventilazione al minimo e la potenza di combustione al massimo

Heizleistung sowie Gebläseleistung sind unterschiedlich einstellbar. Es ist möglich, bei höchster Heizleistung trotzdem die kleinste und leiseste Gebläseleistung zu wählen

Ventilation and output power set up levels are independent: it is possible to set the ventilation at minimum and output power at maximum

Les niveaux de ventilation et de puissance de combustion sont indépendants : il est possible de réguler le niveau de ventilation au minimum et la puissance de combustion au maximum, pour bien se chauffer dans le plus grand silence

Los niveles de ventilación y potencia son independientes. Esto permite poner el nivel de ventilación al mínimo y la potencia de combustión al máximo

Sistema di filtraggio della polvere facilmente ispezionabile e lavabile

Raumluftfilter; Der Filter ist einfach zu reinigen

Warm air filtering system; the filter is easy to check and clean

Système de filtrage de l'air chaud : le filtre s'inspecte et se lave facilement

Sistema de filtración del aire de calefacción con filtro que se puede inspeccionar y lavar fácilmente

Il pannello digitale LCD di nuovo design è implementato da messaggi grafici semplici ed intuitivi

Das neue Bedienfeld wurde mit verschiedenen einfachen Symbolen und Mitteilungen ausgestattet

The new design of control panel has been updated with simple visual messages

Le panneau digitale LCD au design entièrement nouveau propose des messages graphiques simples et intuitifs

La pantalla LCD de nueva generación ha sido actualizada utilizando mensajes gráficos sencillos e intuitivos

Flusso d'aria calda orientabile

Unterschiedlich einstellbare Warmluftauslässe

Directable and adjustable air flow

Flux d'air chaud orientable

Flujo de aire orientable y direccionable

Pratico e igienico piano scaldia vivande di facile pulizia

Hygienische, simpel zu reinigen, speiseaufwärmende Platte zum kochen ist vorhanden

Incorporates practicality and hygiene, easy to clean hotplate heats food

Chauffe-plats pratique et hygiénique, simple à nettoyer

Práctico plano para calentar comidas higiénico y fácil de limpiar

Capace di distribuire il calore in più ambienti e riscaldare più locali anche su piani diversi

Kann Wärme auf mehrere Räume verteilen und mehrere Räumlichkeiten auf verschiedenen Stockwerken beheizen

Capable of distributing heat to various rooms, even on different floors

Capable de distribuer la chaleur dans plusieurs pièces et de chauffer plusieurs locaux, même sur différents étages

Capaz de distribuir el calor en varias habitaciones y calentar varios locales, aunque estén en pisos diferentes

Buciatore brevettato PelletPower®

Patentierter Brenner PelletPower®

PelletPower® patented burner

Brûleur breveté PelletPower®

Quemador patentado PelletPower®

Ogni stufa è dotata di componenti meccanici che garantiscono una maggiore sicurezza dell'apparecchio, come ad esempio una valvola di sovrappressione e un pressostato

Ausgestattet mit mechanische Sicherheitseinrichtungen wie zum Beispiel Entlüftungsventil und Druckreduzierventil

Every stove is equipped with mechanical safety devices that assure an added safety, such as over-pressure valve and pressure switch

Chaque poêle est doté de composants mécaniques qui garantissent une plus grande sécurité comme, entre autres, la soupape de surpression et le pressostat

Cada estufa es equipada con componentes mecánicos que garantizan la seguridad del equipo, como por ejemplo la valvula de sobrepresión y el pressostato

Focolare con ampia visione del fuoco a 270°

Feuer mit einem Öffnungswinkel von 270°

Fire view with an opening angle of 270°

Foyer avec vue sur le feu à 270°

Hogar con amplia vista a 270° de la llama

Possibilità di installare la stufa affinché prelevi aria primaria per la combustione dall'esterno, limitando il consumo di ossigeno nei locali.

Option, um Verbrennung-Primärluft von aussen zu nehmen, um Sauerstoffverbrauch im Raum zu vermeiden

Option to take combustion primary air from outside, in order to avoid oxygen consumption in the room

Possibilité de prélever directement l'air primaire de combustion depuis l'extérieur, pour limiter la consommation d'oxygène dans les locaux

Posibilidad de tomar aire primario de combustión desde el exterior, limitando el consumo de oxígeno en las habitaciones

Thermorossi - I perché di una scelta

Die gründe einer Wahl - Why to choose Thermorossi? - Pourquoi Thermorossi? - Los motivos de una elección



Scatola di distribuzione dell'aria canalizzata
Air ducting distribution box

Uscita canalizzazione posteriore sinistra
Duct vent rear left

Uscita canalizzazione posteriore destra
Duct vent rear right

Scambiatore a fascio tubiero THERMOCORE®
THERMOCORE® pipe heat exchanger

THERMOCORE®



2m x 1
1m x 2

2 metri di canalizzazione utilizzando 1 uscita
1 metri di canalizzazione utilizzando 2 uscite
2 meters of ducting using 1 outlet
1 meters of ducting using 2 outlets



8m x 1
4m x 2

8 metri di canalizzazione utilizzando 1 uscita
4 metri di canalizzazione utilizzando 2 uscite
8 meters of ducting using 1 outlet
4 meters of ducting using 2 outlets



10m x 1
5m x 2

10 metri di canalizzazione utilizzando 1 uscita
5 metri di canalizzazione utilizzando 2 uscite
10 meters of ducting using 1 outlet
5 meters of ducting using 2 outlets



12m x 1
6m x 2

12 metri di canalizzazione utilizzando 1 uscita
6 metri di canalizzazione utilizzando 2 uscite
12 meters of ducting using 1 outlet
6 meters of ducting using 2 outlets



15m x 1
5m x 2

15 metri di canalizzazione utilizzando 1 uscita
5 metri di canalizzazione utilizzando 2 uscite
15 meters of ducting using 1 outlet
5 meters of ducting using 2 outlets



16m x 1
8m x 2

16 metri di canalizzazione utilizzando 1 uscita
8 metri di canalizzazione utilizzando 2 uscite
16 meters of ducting using 1 outlet
8 meters of ducting using 2 outlets



Ventilatore ambiente ermetico alla polvere garantito 4 anni
Room fan, hermetic to the dust, granted 4 years

- ITA Il fascio tubiero verticale e l'elevato numero di elementi formano il sistema Thermocore®. Il sistema incrementa la superficie di scambio e migliora il rendimento termico.
- DEU Der vertikale Rohrwärmetauscher mit großer Wärmetauscherfläche ist das Herzstück des Thermocore Systems. Dieses System steigert die Wärmetauscherfläche und erhöht den Wirkungsgrad.
- ENG The vertical pipes heat exchanger and the high number of exchange elements form the Thermocore system. This system increases the exchange surface and improve thermal efficiency.
- FRA Le faisceau tubulaire vertical et ses nombreux éléments forment le système Thermocore®, qui augmente la superficie d'échange de chaleur et améliore le rendement thermique.
- ESP El intercambiador turbolador vertical de muchos elementos crea el sistema Thermocore. Este sistema aumenta la superficie de intercambio y mejora el rendimiento térmico.



L'ampio vetro panoramico
permette di ammirare il fuoco
in assoluto silenzio
The large panoramic glass
allows you to enjoy the
charm of fire in complete silence

SILENT[®] system

- ITA I modelli Silent, appositamente studiati per garantire il massimo comfort acustico, sono ideali per coloro che soffrono di allergie alla polvere o semplicemente per le case a basso consumo energetico che richiedono potenze termiche inferiori. Lo scambio termico avviene per un movimento naturale dell'aria, ossia per convezione naturale. All'elevato livello di silenziosità si aggiunge la riduzione di consumo elettrico.
- DEU Dies geschieht über die natürliche Konvektion ohne zusätzliches Gebläse. Die Silent Modelle, speziell entwickelt um den Geräuschkomfort zu steigern, sind auch ideal für Stauballergiker oder für den Einsatz in Niedrigenergiehäusern mit geringem Energiebedarf. Der geringere Energieverbrauch harmonisiert mit der geringeren Heizleistung und der geringeren Geräuschemission.
- ENG The silent models, specifically designed to maximize acoustic comfort are ideal for those who suffer from dust allergies or simply for energy efficient houses that have lower heat demands. The heat exchange utilises the natural movement of the air, i.e. by natural convection. The lower level of noise corresponds to a lower level of energy consumption.
- FRA Les modèles Silent, étudiés exprès pour garantir un confort acoustique maximum, sont idéaux pour les personnes qui souffrent d'allergies à la poussière, mais aussi pour les maisons à basse consommation énergétique qui nécessitent de puissances thermiques réduites. L'échange thermique est généré par un courant d'air naturel : la convection. Au silence de fonctionnement s'ajoute la réduction de la consommation d'électricité.
- ESP Los modelos Silent, específicamente diseñados para garantizar el máximo confort acústico, son ideales para aquellos que sufren de alergia al polvo o simplemente para viviendas de bajo consumo energético que requieren menos capacidad de calefacción. El intercambio de calor se genera del movimiento natural del aire, es decir por convección natural. Al bajo nivel de ruido se añade ahorro eléctrico.

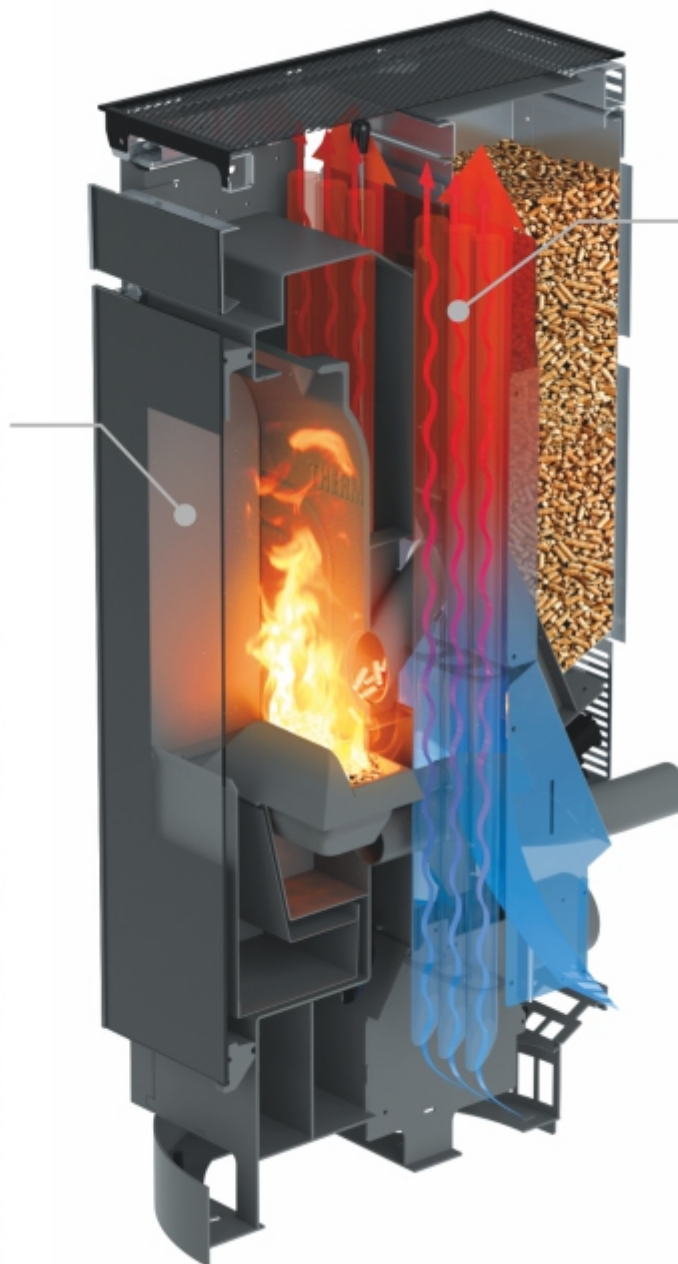

Il calore accumulato viene diffuso
in modo uniforme e naturale
senza l'uso del ventilatore ambiente
Stored heat is distributed both equally
and naturally, without fan ventilation

Ideale in caso di allergie
alla polvere e per le case a
basso consumo energetico
che richiedono potenze
termiche inferiori
Ideal for those who suffer
from dust intolerances,
and for the energy efficient
houses that have lower
heat demand.

Ghisa, acciaio, maiolica
diffondono il calore
attraverso l'irraggiamento
Cast iron, steel and
ceramic spread heat to the
environment.

All'elevato livello di
silenziosità si aggiunge la
riduzione di consumo
elettrico.
Lower level of noise means
lower level of energy
consumption



Rendimenti superiori al 90% ottenuti grazie al bruciatore brevettato che sviluppa 2 fronti di fiamma in grado di cedere il calore sia agli scambiatori centrali che laterali normalmente inutilizzati nella combustione a pellet.

Wirkungsgrade von mehr als 90% dank des patentierten Brenners, der zwei Flammfronten entwickelt und so in der Lage ist, die Wärme gleichzeitig an die mittleren und an die seitlichen Wärmetauscher abzugeben, die normalerweise bei der Pelletverbrennung nicht benutzt werden.

Over 90% efficiency is achieved thanks to the patented burner which develops 2 flame fronts capable of not only transmitting heat to the central heat exchangers but also to the ones on the side which are normally unused in pellet combustion.

Rendements supérieurs à 90% obtenus grâce au brûleur breveté qui développe 2 fronts de flamme en mesure de céder la chaleur aussi bien aux échangeurs centraux que latéraux normalement inutilisés dans la combustion de granulés de bois.

Rendimientos superiores al 90% obtenidos gracias al quemador patentado que desarrolla 2 frentes de llama capaces de ceder el calor tanto a los intercambiadores centrales como a los laterales, normalmente inutilizados en la combustión con pellets.



- I residui della combustione vengono rimossi ai lati
- Combustion residues are moved to the sides
- Il sistema di pulizia funziona di continuo senza dover spegnere il generatore
- The cleaning system works continuously and there is no need to switch the unit off
- Rendimento superiore e costante, l'ammortamento del generatore avviene in tempi più brevi
- Higher and stable burning efficiency; the startup period is shortened

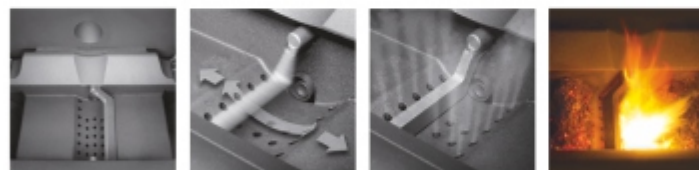

PELLETPOWER® system

- ITA I residui della combustione vengono rimossi dal dispositivo automatico mantenendo liberi i fori di passaggio dell'aria al bruciatore. Rendimento di combustione superiore rispetto ai bruciatori tradizionali a vaschetta, PELLETPOWER® garantisce il giusto apporto di ossigeno mantenendo costante il rendimento di combustione per lunghi tempi di funzionamento;
- DEU Der Brenner wird automatisch von den Verbrennungsrückständen befreit und somit bleiben die Luftöffnungen permanent sauber. Somit kann der Ofen permanent heizen und unnötiger Brennstoffverbrauch beim Startvorgang wird vermieden. Höherer Wirkungsgrad gegenüber herkömmlichen Systemen durch PELLETPOWER erreicht der Ofen ein korrektes Sauerstoffverhältnis in der Verbrennung und hält den Wirkungsgrad der Verbrennung über lange Zeiten hoch;
- ENG Residues of burning are removed by the automatic system keeping the holes which take air to the burner completely free. Higher burning efficiency compared to traditional pan burners PELLETPOWER maintains the correct rate of oxygen keeping the efficiency of combustion stable for longer periods of operation;
- FRA Les résidus de combustion sont balayés par le dispositif automatique, gardant les orifices de passage d'air du brûleur toujours libres. Rendement de combustion supérieur par rapport aux brûleurs traditionnels en forme de cuvette. Le PELLETPOWER® garanti le juste apport d'oxygène, maintenant le rendement de combustion constant, même en cas de fonctionnements prolongés;
- ESP Dispone de un sistema automático que despeja los residuos de combustión manteniendo los agujeros de paso de aire al quemador libres. El rendimiento de combustión es superior de los quemadores tradicionales a cubeta. PELLETPOWER: Garantiza el correcto aporte de oxígeno manteniendo un rendimiento constante de combustión por largos tiempos de operación. La amortización de la máquina se realiza más rápidamente.



THERMOCELL 250®
THERMOCELL 400®
THERMOCELL 500®
Accumuli a stratificazione
Geschichtete termische
Pufferspeichern
Stratification thermal stores
Ballon d'Accumulation à stratification
Acumulaciòn tèrmico a estratificaciòn

THERMOPUFFER 400
THERMOPUFFER 500
Accumulo (puffer)
Pufferspeicher
Puffer tank
Reservoir d'accumulation (puffer)
Estanque (puffer)

INTEGRA TR-PACK

ITA Generatore a pellet abbinato a pannelli solari e accumuli.
L'impianto termoidraulico deve essere realizzato secondo normativa locale e dotato di tutti gli accessori di sicurezza e controllo.

DEU Pelletwärmeerzeuger mit Solar- und Speicheranschluss.
Die Heizanlage muss die geltenden Bestimmungen befolgen und mit allen lokalen Sicherheits- und Kontrollelementen versehen sein.

ENG Pellet boiler paired to solar heating system. All installations must be realized following local current normatives and must be provided with check up and safety instruments.

FRA Générateurs de chaleur à pellet accouplée aux panneaux solaire. L'installation de chauffage doit être réalisé suivant les réglementations locales et avoir tous les systèmes de sécurité et contrôle.

ESP Calentador de pellets combinado con placa solar. Cada instalación termohidráulica tiene que ser realizada según normativa local y dotada de todos los accesorios de seguridad y control.

THERMOSOLE®2.0
THERMOSOLE®2.6
Collettore solare
Solarkollektoren
Solar heating unit
Panneaux solaire
Placa solar





Settecento



Dorica



Saint Moritz - Lienz - Montreux



Aromy



Piano igienico, in cristallo*
con funzione di scalda vivande**
Optional: Dinner**
Glass top plate*
with food warming function**
Optional: Dinner**

PIANO IGIENICO

SCALDA VIVANDE

- ITA Di serie, la comodità dei nostri piani scaldavivande** in cristallo*, igienici e facili da pulire. Posizionato sopra al focolare permette di assaporare squisite pietanze, mantenendo i tuoi cibi sempre caldi. Disponibile per i modelli: Mon Amour, Dorica**, Aromy**, Saint Moritz**, Lienz**, Montreux** e Settecento*.
- DEU Serienmäßig, die Bequemlichkeit unserer Speiseaufwärmplatte** aus Kristall*, hygienisch und einfach zu reinigen. Über dem Ofen positioniert, erlaubt sie, köstliche Gerichte zu genießen, indem sie Ihre Speisen immer warm hält. Für folgende Modelle verfügbar: Mon Amour, Dorica**, Aromy**, Saint Moritz**, Lienz**, Montreux** und Settecento*.
- ENG Included: the comfort of our glass top plates* for food warming**, hygienical and easy to clean. Located on top of firebox, keeps your foods warm for a perfect taste. Available for models MonAmour, Dorica**, Aromy**, Saint Motritz**, Lienz**, Montreaux**, Settecento*.
- FRA De série, la commodité de nos chauffe-plats** en cristal*, hygiéniques et simples à nettoyer. Situé au-dessus du foyer, il permet de déguster des mets exquis, gardant les aliments toujours chauds. Disponible pour les modèles : Mon Amour, Dorica**, Aromy**, Saint Moritz**, Lienz**, Montreux** et Settecento*.
- ESP La comodidad de nuestras tapas calientaplatos** en cristal* es incluida, higiénica y facil de limpiar. Colocada arriba del hogar permite de saborear exquisitos platos, preservando tus comidas siempre calientes. Disponible para los modelos Mon Amour, Dorica**, Aromy**, Saint Moritz**, Lienz**, Montreux** y Settecento*.



DINNER

COPERCHIO SCALDA VIVANDE

ITA Optional, la pratica cupola scaldavivande in cristallo, removibile e lavabile in lavastoviglie. Riscalda più velocemente i tuoi spuntini, aumenta la superficie per il riscaldamento delle tue pietanze e serve in tavola le tue specialità, con l'elegante design del vassoio. Disponibile per i modelli: Mon Amour, Settecento, Dorica*, Aromy* e Saint Moritz*.

DEU Optional, die praktische warmhalterfläche Kuppel aus Kristall ist abnehmbar und geschirrspülfest. Wärmt deine Jausen schnell auf - Erhöht die Oberfläche zur Aufwärmung deiner Speisen - Tisch deine Spezialitäten dank dem eleganten Plattendesign auf. Für folgende Modelle verfügbar: Mon Amour, Settecento, Dorica*, Aromy* und Saint Moritz*.

ENG Optional, practical glass cover for food warming, removable and easy to clean in your dishwasher. Warms faster your snacks, increases the warming surface and bring it directly to the table thanks to its smart design. Available for models Mon Amour, Settecento, Dorica*, Aromy* and Saint Moritz*.

FRA En option, la coupole chauffe-plats en cristal, pratique, amovible, et lavable au lave-vaisselle. Pour réchauffer vos petits plats plus rapidement, pour augmenter la surface de chauffe à votre disposition, pour servir à table vos spécialités sur un plateau design et élégant. Disponible pour les modèles : Mon Amour, Settecento, Dorica*, Aromy* et Saint Moritz*.

ESP Opcional, una practica tapa calentaplatos en cristal, removable y lavable en lavaplatos. Calienta más rápido tus comidas, se puede servir directamente en la mesa gracias a su diseño elegante. Disponible para los modelos Mon Amour, Settecento, Dorica*, Aromy* y Saint Moritz*.





1000 easy

ITA Il colore grigio antracite e le finiture curate permettono di integrare Easy in qualsiasi ambiente.

DEU Mit seiner anthrazitgrauen Farbe und den sorgfältig verarbeiteten Reliefflächen fügt sich Easy problemlos in jede Umgebung ein.

ENG Its anthracite grey colour and its meticulous finish with bas-relief details make it the perfect unit for any room.

FRA Grâce à sa couleur gris anthracite et à ses finitions soignées, l'Easy peut être intégré dans n'importe quel milieu.

ESP El color gris antracita y los esmerados acabados con especiales mecanizaciones en bajo relieve permiten integrar Easy en cualquier ambiente.

Uscite fumi disponibili: posteriore - laterale sinistro (optional)
 Flue outlet options: rear - left side (optional)



• External primary air input (optional)
 Input esterno dell'aria primaria;
 Eintritt der primäre Luft vom außen;
 External primary air input;
 Entrée d'air primaire externe;
 Entrada externa de aire primario;



• Installazione salva spazio (optional)
 Curva 90° per scarico fumi laterale sinistro;
 Space-saving installation (optional)
 90° curved pipe for left-side flue outlet;

Grigio

Uscita fumi laterale sinistra salvaspazio (optional)
 Left side space-saving flue outlet (optional)

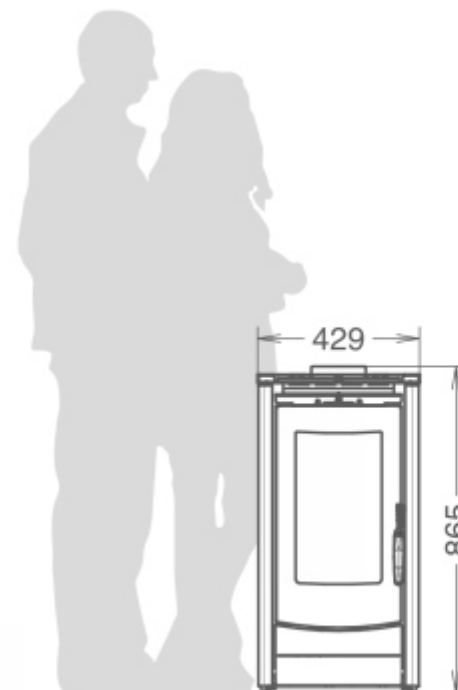

58



865x429x504



2,9 - 7,5



2,5 - 6,4



0,6 - 1,5



14



1000 metalcolor

- ITA Stufa a pellet di misure contenute ad alte prestazioni, sviluppa una potenza di 7 kW, riscalda 175 m³ e offre un'inimitabile silenziosità (36 decibel).
- DEU Pelletofen mit ausgezeichneten Leistungsmerkmalen, der trotz des geringen Platzbedarfes eine Leistung von 7 kW entwickelt, ein Raumvolumen von 175 m³ beheizt und unnachahmlich leise läuft (36 dB).
- ENG Small size, high performance pellet heater; it delivers 7 kW of power, it provides heat to 175m³ of space and its silent operation is hard to beat (36 dB).
- FRA Poêle à granulés aux dimensions, réduites et aux hautes performances, il développe une puissance de 7 kW, chauffe 175 m³ et garantit un silence inégalable (36 dB).
- ESP Estufas de pellet de medidas contenidas con altas prestaciones, desarrolla una potencia de 7 kW, calienta 175 m³ y garantiza un silencio inimitable (36 dB).

Uscite fumi disponibili: posteriore - laterale sinistro (optional)
 Flue outlet options: rear - left side (optional)

Schermo comandi programmabile, con telecomando
 Programming control panel, with remote control

Preziosa maiolica artigianale fatta a mano
 Precious handmade majolica by master craftsmen

Bruciatore in ghisa
 Cast iron burner

Maniglia antiscottatura
 Anti-burn door handle

Uscita fumi laterale sinistra salvaspazio (optional)
 Left side space-saving flue outlet (optional)



• External primary air input (optional)
 Input esterno dell'aria primaria;
 Eintritt der primäre Luft vom außen;
 External primary air input;
 Entrée d'air primaire externe;
 Entrada externa de aire primario;



• Installazione salva spazio (optional)
 Curva 90° per scarico fumi laterale sinistro;
 Space-saving installation (optional)
 90° curved pipe for left-side flue outlet;

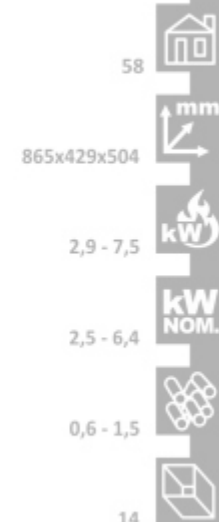
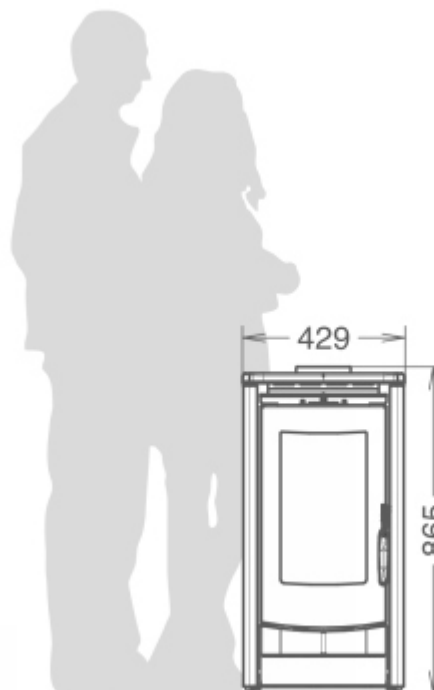

1500 maiolica

ITA Le maioliche avvolgono la stufa per non rinunciare alla tradizione di un tempo e avvicinarsi alle esigenze di oggi.

DEU Die Fayence, die umgibt den Ofen, um nicht verzichten die Traditionen der Vergangenheit und rücken näher an die Bedürfnisse von heute.

ENG Model 1500 features a casing of majolica, to accommodate both traditional usage and modern requirements.

FRA Les carreaux de faïence habillent le modèle 1500 pour ne pas renoncer à la tradition d'autrefois tout en essayant de satisfaire les exigences d'aujourd'hui.

ESP Las mayólicas envuelven el modelo 1500, para no renunciar a la tradición de un tiempo y acercarse además a las exigencias de hoy.

Uscite fumi disponibili: posteriore - laterale sinistro (optional)
 Flue outlet options: rear - left side (optional)

Schermo comandi programmabile, con telecomando
 Programming control panel, with remote control

Preziosa maiolica artigianale fatta a mano
 Precious handmade majolica by master craftsmen

Uscita fumi laterale sinistra salvaspazio (optional)
 Left side space-saving flue outlet (optional)

Maniglia anticottatura
 Anti-burn door handle

Bruciatore in ghisa
 Cast iron burner

L' elegante design rialzato della base facilita la pulizia
 The refined raised base makes the cleaning easier



• External primary air input (optional)
 Input esterno dell'aria primaria;
 Eintritt der primäre Luft vom außen;
 External primary air input;
 Entrée d'air primaire externe;
 Entrada externa de aire primario;



• Installazione salva spazio (optional)
 Curva 90° per scarico fumi laterale sinistro;
 Space-saving installation (optional)
 90° curved pipe for left-side flue outlet;

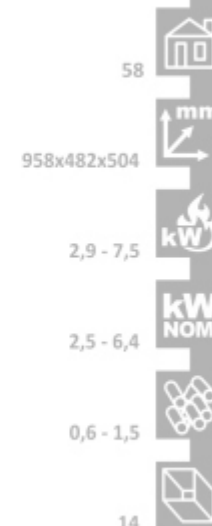
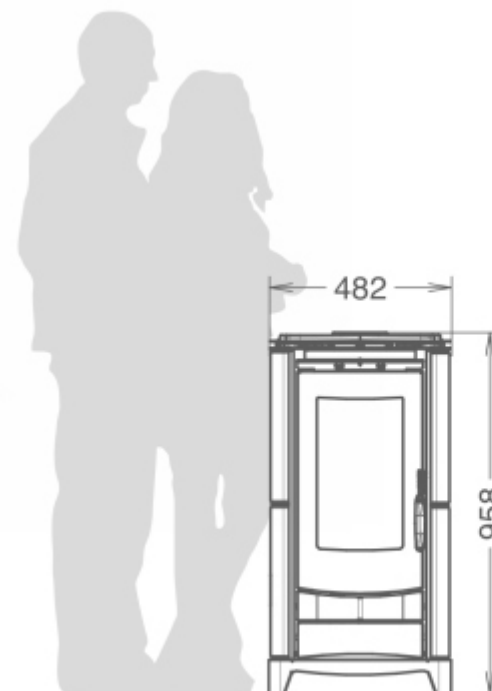



MON AMOUR

- ITA Stufa a pellet curata nei particolari si integra facilmente grazie alla sua atmosfera calda e preziosa. Dotata del pratico scaldavivande scorrevole in cristallo igienico e di facile pulizia sopra al quale è possibile appoggiare il versatile coperchio scalda vivande Dinner (optional).
- DEU Der Pelletofen mit dem besonderen Etwas! Er fügt sich überall dank seiner unauffälligen Art ein und ist ein treuer Begleiter wenn Sie es warm haben wollen. Ausgestattet mit einer hygienischen Warmhaltefläche aus Glas, einfach zu Reinigen und optional auszustatten mit der Dinner Abdeckung.
- ENG Pellet stove made with particular attention to detail easily integrated thanks to its warm and precious nature. Equipped with the practical hot plate in hygienic glass, easy to clean and supports the optional cover Dinner.
- FRA Poêle à granulés aux détails soignés, qui s'intègre aisément, créant une atmosphère chaude et moderne. Doté d'un chauffe-plats coulissant en cristal, pratique et hygiénique, simple à nettoyer, qui peut être complété (en option) par le couvercle-chauffe-plats Dinner.
- ESP Estufa de pellets cuidada en todos detalles que se puede integrar fácilmente gracias a su ánimo cálido y precioso. Equipado con un práctico plano para calentar comidas hecho en cristal higiénico y fácil de limpiar, al cual se puede añadir la versátil tapa Dinner (opcional).



Accesso scorrevole per il caricamento del pellet
Sliding top access to the pellet tank

Piano scalda vivande igienico, in cristallo. Optional: Dinner
Practical food warming plate in hygienic glass. Optional: Dinner

Maniglia removibile. Essenzialità nel design e maggior sicurezza
Removable door handle. Essential design and high safety

Preziosa porta focolare in cristallo e ghisa
Precious cast iron and glass firebox door



• **Dinner (optional)**
Coperchio scalda vivande in cristallo;
Warmhalteplatte aus Kristallglas;
Couvercle chauffe-plat en crystal;
Glass food-warming cover;
Chapa para calentar comidas;



• **Thermocomfort (optional)**
Radiocomando con termostato ambiente;
Funksteuerung mit Raumthermostat;
Radio control with room thermostat;
Radiocommande avec thermostat d'ambiance;
Radio control con termostato de ambiente;



Pannello LCD di nuovo design implementato da messaggi grafici semplici ed intuitivi
The new design of control panel has been updated with simple visual messages

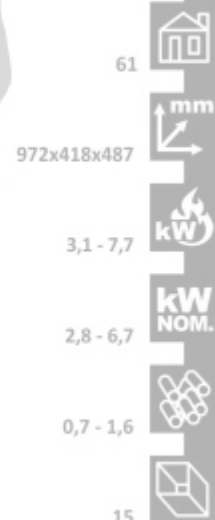
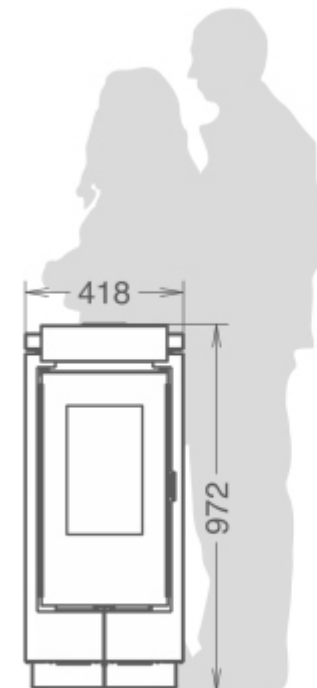



2000

ITA Fatevi trasportare dall'eleganza delle forme e dalla cura dei dettagli.

DEU Lassen Sie sich verzaubern von der Eleganz der Form und Liebe zum Detail.

ENG Be carried away by this stylish and elegant design manufactured with great care for details.

FRA Laissez-vous transporter par l'élégance des formes et le soin du détail.

ESP Déjate llevar por la elegancia de las formas y los cuidados detalles.



Accesso scorrevole per il caricamento del pellet;
raffinato fregio del coperchio in maiolica
Sliding top access to the pellet tank; refined majolica decoration on the top

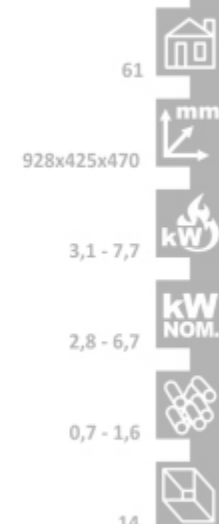
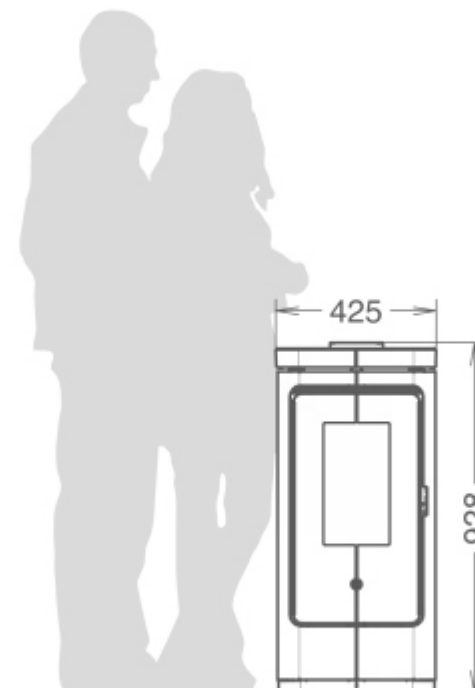



CIAO

ITA Il nuovo archetipo di stufa che guarda al futuro con un design giovane e moderno.

DEU Der neue Ofen, der auf die Zukunft sieht mit einer jungen und modernen Design.

ENG Young and modern design from Thermorossi with an open eye on the future.

FRA Le nouvel archétype de poêle qui vise au futur avec un design jeune et moderne.

ESP El nuevo arquetipo de estufa que mira hacia el futuro con su diseño joven y moderno.



Bianco



Verde



Celeste



Bordeaux



Grgio



Nero

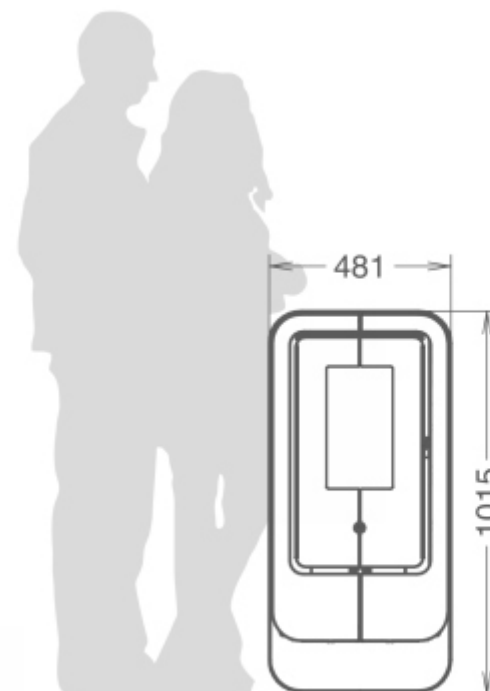

61



mm



1015x481x588

3,1 - 7,7



2,8 - 6,7



0,7 - 1,6



14



SLIM thermocomfort

ITA Linee originali che lasciano vivere un'esperienza inedita.

DEU Originelle Ideen, die eine ganz neue Erfahrung vermitteln.

ENG Original lines that create an original living experience.

FRA Des formes originales qui offrent l'occasion de vivre une expérience inédite.

ESP Líneas originales que permiten vivir una experiencia inédita.

Uscite fumi disponibili:
superiore-posteriore-laterale sinistro
Flue outlet options: top-rear-left side

Uscite per canalizzazione disponibili:
superiore - posteriore
Duct vents options: top - rear

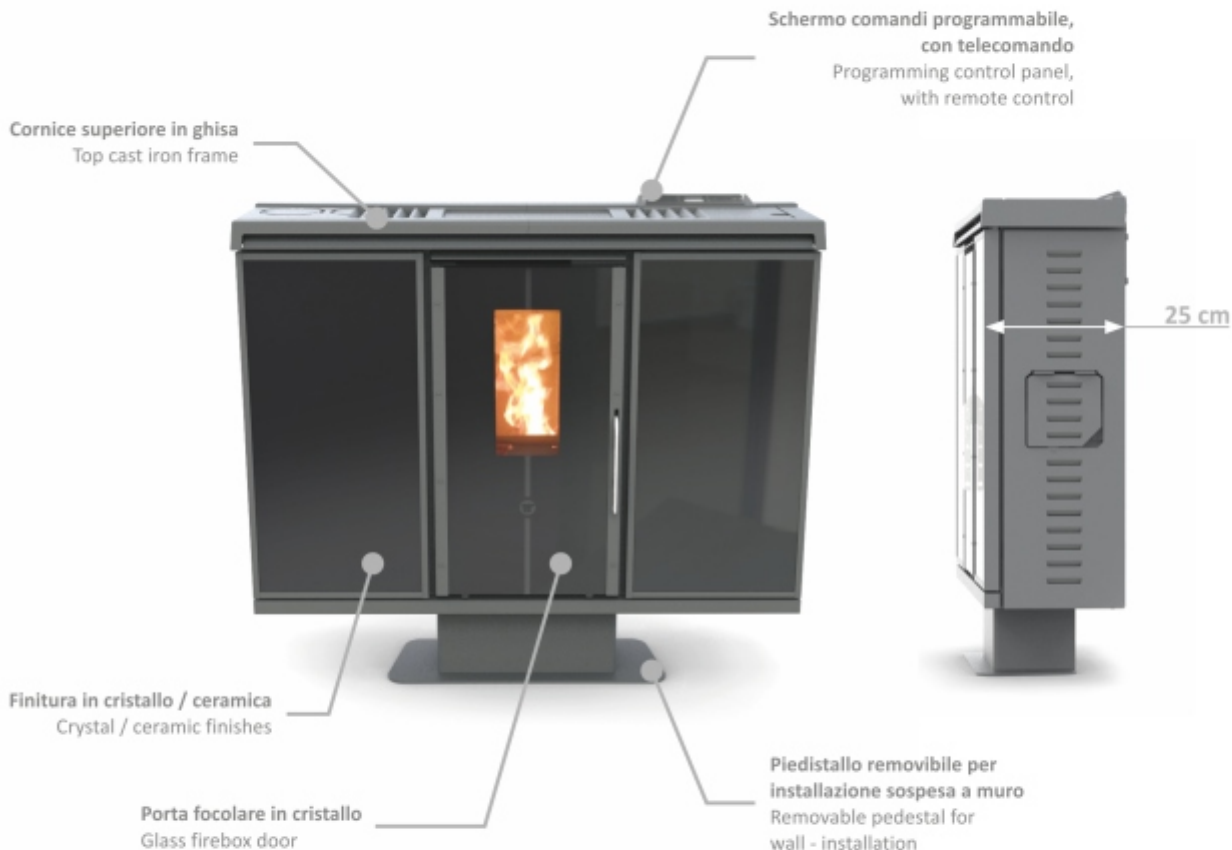

• **Thermocomfort (optional)**
Radiocomando con termostato ambiente;
Funksteuerung mit Raumthermostat;
Radio control with room thermostat;
Radiocommande avec thermostat d'ambiance;
Radio control con termostato de ambiente;

- Cristallo
- Bianco
- Bordeaux
- Nero
- Ceramica
- Madreperla
- Ollare
- Bronze

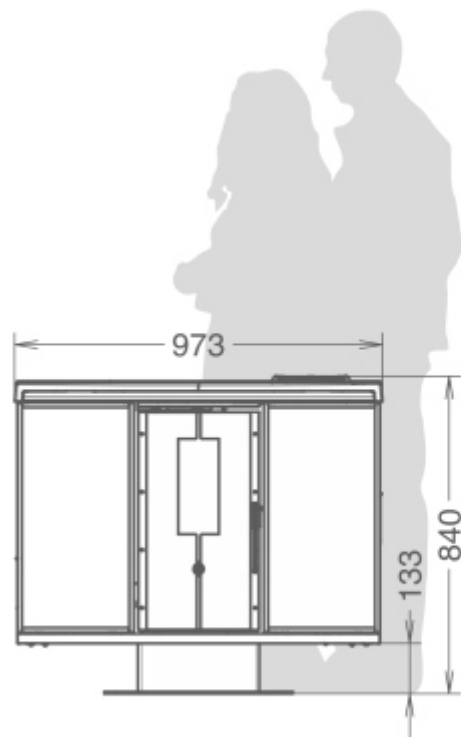

- 67
- mm
- 840x973x260
- 3,0 - 8,2 kW
- 2,7 - 7,4 kW NOM.
- 0,6 - 1,7
- 12





SLIMQUADRO 9

- ITA L'esclusivo design brevettato salva spazio dal successo internazionale è ora disponibile per il modello dalle misure più contenute. Dotata del sistema di canalizzazione multi direzionale MULTI WAY AIR SYSTEM, scambiatore di calore THERMOCORE® e pulizia ordinaria e straordinaria semplificata EASY CLEANING. Disponibile in cristallo colorato in tinta unita oppure nelle versioni Moondecor e Sundecor.
- DEU Das einzigartige, patentierte und platzsparende Design ist nun auch in einem kleineren Modell erhältlich. Ausgestattet mit dem Warmluftverteilsystem MULTI WAY AIR SYSTEM, dem Wärmetauscher THERMOCORE® und dem einfachen EASY CLEANING Reinigungssystem. Verfügbar in farbigem Frontglas sowie in den Versionen Moon decor oder Sun decor.
- ENG The unique patented design that saves space which is an international success is now available for smaller models. Equipped with multi-directional MULTI WAY AIR SYSTEM, heat exchanger THERMOCORE® and simplified cleaning system EASY CLEANING. Available in colored glass or with versions Moon decor or Sun decor.
- FRA Le design à encombrement réduit, exclusif et breveté, du SlimQuadro 11, fort de son succès international, est maintenant disponible dans cette version aux dimensions et puissance plus contenues. Doté du système multidirectionnel de canalisation du flux d'air chaud MULTI WAY AIR SYSTEM, de l'échangeur de chaleur THERMOCORE®, et du système de nettoyage ordinaire et extraordinaire simplifié EASY CLEANING. Disponible avec cristal coloré, uni ou dans les versions Moondecor et Sundecor.
- ESP El diseño único y patentado para ahorrar espacio de gran éxito internacional está ahora disponible en una versión de tamaño más reducido. Equipado con sistema de canalización multidireccional MULTI-WAY AIR SYSTEM, intercambiador de calor THERMOCORE® y limpieza ordinaria y extraordinaria simplificadas EASY CLEANING. Disponible en la versión de cristal de color uniforme o en los nuevos Moondecor y Sundecor.

Uscite fumi disponibili:
superiore-posteriore-laterale sinistro
Flue outlet options: top-rear-left side

Uscite per canalizzazione
disponibili: 2 posteriori
1 lato sinistro - 1 lato destro
Duct vents options:
2 rear - 1 side right
1 side left

Multyway Air System: flusso aria orientabile
(fronte-retro-destro-sinistro)
Multyway Air System: adjustable air flow
(front -rear-right-left)

Maniglia removibile.
Essenzialità nel design
e maggior sicurezza
Removable door handle.
Essential design
and high safety

Preziosa porta focolare
in cristallo e ghisa
Precious cast iron
and glass firebox door

Piedistallo removibile
per installazione sospesa a muro
Removable pedestal
for wall-installation

Finitura in cristallo
Crystal finishes



• Thermocomfort (optional)
Radiocomando con termostato ambiente;
Funksteuerung mit Raumthermostat;
Radio control with room thermostat;
Radiocommande avec thermostat d'ambiance;
Radio control con termostato de ambiente;

Cristallo

Bianco

Bordeaux

Nero

Cristallo
Decor

Sundecor

Moondecor

27 cm

Schermo comandi programmabile,
con telecomando
Programming control panel,
with remote control

77

mm

937x950x281

3,8 - 9,8

3,4 - 8,5

0,8 - 2

17



10m x 1
5m x 2



SLIMQUADRO¹¹ e IDRA

- ITA Thermorossi cambia i confini tra spazi e funzioni, la stufa diventa un "mobile" da inserire in assoluta libertà, un quadro da appendere dall'esclusivo design brevettato. Dotata di scambiatore di calore THERMOCORE® e pulizia ordinaria e straordinaria semplificata EASY CLEANING, disponibile in cristallo colorato in tinta unita oppure nelle versioni Moondecor e Sundecor. La versione Idra è dotata di bruciatore motorizzato con tecnologia PELLETPOWER®.
- DEU Thermorossi verändert die Grenzen zwischen Raum und Funktion, wird die Heizung ein "Möbel" am Wille, ein Bild zu hängen platzient werden. Ausgestattet mit dem Wärmetauscher THERMOCORE® und dem einfachen EASY CLEANING Reinigungssystem. Verfügbar in farbigem Frontglas sowie in den Versionen Moondecor oder Sundecor. Version Idra ist mit dem PELLETPOWER® Patentierte Brenner ausgestattet.
- ENG Thermorossi moves the borders between space and function. The heater becomes a masterpiece to be exhibited, a "piece of furniture" to be placed at will, a picture to be hanged. Equipped with heat exchanger THERMOCORE® and simplified cleaning system EASY CLEANING. Available in coloured glass or with versions Moondecor or Sundecor. The version Idra is equipped with the PELLETPOWER® technology patented burner.
- FRA Thermorossi modifie les frontières entre espaces et fonctions, le poêle devient un tableau à accrocher, un "meuble" à insérer en toute liberté. Doté de l'échangeur de chaleur THERMOCORE® et du système de nettoyage ordinaire et extraordinaire simplifié EASY CLEANING. Disponible avec cristal coloré, uni ou dans les versions Moondecor et Sundecor. Version Idra est équipé du brûleur motorisé avec technologie PELLETPOWER®.
- ESP Thermorossi cambia las fronteras entre espacios y funciones, la estufa se convierte en un cuadro para colgar, un "mueble" para combinar libremente. Equipada con intercambiador de calor THERMOCORE® y limpieza ordinaria y extraordinaria simplificadas EASY CLEANING. Disponible en la versión de cristal de color uniforme o en los nuevos Moondecor y Sundecor. Versión Idra es equipada con la tecnología de quemador motorizado PELLETPOWER®.

Uscite fumi disponibili*:
superiore - posteriore - laterale sx
Flue outlet options*:
top-rear-left side

Multyway Air System*:
flusso aria orientabile
(fronte - retro - dx - sx)
Multyway Air System*:
adjustable air flow
(front - rear-right-left)

Uscite per canalizzazione disponibili*:
2 posteriori, 1 lato sx, 1 lato dx
Duct vents options*:
2 rear, 1 left side, right side

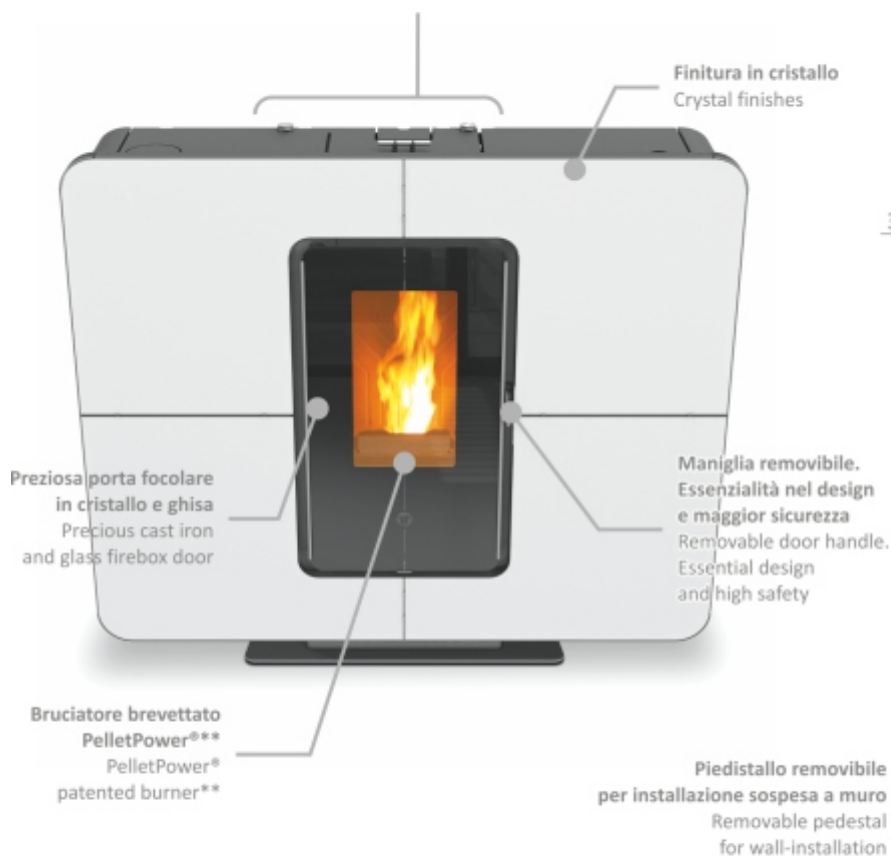

• Thermocomfort (optional)*
Radiocomando con termostato ambiente;
Funksteuerung mit Raumthermostat;
Radio control with room thermostat;
Radiocommande avec thermostat d'ambiance;
Radio control con termostato de ambiente;



• INTEGRA TR-PACK (optional)**
Thermocell® (250/400/500 lt);
Thermopuffer (400/500 lt);
Thermosole® (2.0 e 2.6);



• Valvola termostatica a 3 vie**
1" FFF 55 OT (optional)
Thermostatic valve 3 ways**
1" FFF 55 OT (optional);
Vanne thermostatique 3 voies**
1" FFF 55 OT (optional);



• Sonda PT100** (optional - min 2 pz)
per funzione «THERMOCONTROL»
PT100 sensor** (optional - min 2 pc)
for «THERMOCONTROL» function
Sonde PT100** (optional - min 2 pces)
pour fonction «THERMOCONTROL»

Schermo comandi
programmabile,
con telecomando*
Programming control panel,
with remote control

Cristallo

Bianco

Bordeaux

Nero

Cristallo
Decor

Sundecor

Moondecor

Plus
92
Idra
120



992 - H
1109 - L
319 - P



Plus
4,8-11,4
Idra
4,9-14,3



Plus
4,5-10,2
Idra
4,7-13,3



Idra
4,1 - 11,9



Plus
1-2,3
Idra
1,1-3,1



Plus
17
Idra
18



PELLETPOWER®

Di serie su termostufe versione «Idra»
Standard on thermo-stoves "Idra" version



16m³
8m³

Plus

Idra

* Solo versione «Plus» - * Only on «Plus» version

** Solo versione «Idra» - ** Only on "Idra" version



SLIMQUADRO idra MAXI

- ITA La collezione Slimquadro®, dall'esclusivo design brevettato salva spazio dal successo internazionale, si arricchisce nella versione idra con un nuovo modello ancora più potente. Ideale per il riscaldamento domestico diventa il cuore dell'impianto, facilmente integrabile grazie alle misure compatte. L'innovativo bruciatore motorizzato con tecnologia brevettata PELLETPOWER® mantiene la resa termica elevata e costante nell'arco dell'intera giornata: mantenere il bruciatore pulito significa ridurre sia la manutenzione ordinaria che i costi di combustibile, con un rapido ammortamento del generatore.
- DEU Die Slimquadro® Kollektion, die innovative platzsparende Produktfamilie mit patentiertem Design welche ausschließlich von Thermorossi mit großem internationalen Erfolg hergestellt wird, wird nun mit einem neuen wassergeführten Modell erweitert, welches noch leistungsfähiger ist. Wenn Sie eine größere Fläche durch eine Pellet-Heizung erwärmen möchten, bietet dieses Produkt die ideale Lösung. Es bildet den Kern des Heizsystems welches dank seiner kompakten Abmessungen einfach im Wohnbereich integriert werden kann. PELLETPOWER® das innovative patentierte Brennersystem hält den Sauerstoffgehalt bei der Verbrennung konstant und hält die Effizienz der Verbrennung für einen langen Zeitraum stabil. Der Brenner wird konstant saubergehalten und somit reduzieren sich die Brennstoffkosten und die Amortisation des Heizgerätes über viele Jahre.
- ENG The Slimquadro® collection, the innovative space - saving patented design, made exclusively by Thermorossi and which is achieving great international success, enhances itself with a new entry: a new idra model, even more powerful. If you would like to heat a domestic environment through a pellet-heating generator, it provides the ideal solution. It becomes the core of the system, easy to be integrated in living zones thanks to its compact dimensions. The PELLETPOWER® innovative patented burner maintains the correct rate of oxygen keeping the efficiency of combustion stable for longer periods: keeping the burner clean means reducing cleaning times and fuel costs, and payback initial heating-generator costs over few years.
- FRA La collection Slimquadro®, au design à encombrement réduit exclusif et breveté, forte de son succès international, s'enrichit dans sa version Idra d'un nouveau modèle encore plus puissant. Idéal pour le chauffage domestique, il devient le cœur du circuit, facilement intégrable grâce à ses mesures compactes. L'innovant brûleur motorisé avec technologie brevetée PELLETPOWER® maintient le rendement thermique élevé et constant tout au long du jour: garder le brûleur propre signifie réduire aussi bien la manutention ordinaire que les frais de combustible, avec un amortissement plus rapide du générateur.
- ESP La gama Slimquadro® de diseño exclusivo, patentado y ahorra-espacio de éxito internacional, se enriquece en la versión idra con un nuevo modelo, aún más potente. Ideal para la calefacción del hogar, se convierte en el centro de la instalación integrándose fácilmente gracias a sus medidas compactas. El quemador motorizado con tecnología patentada PELLETPOWER® mantiene constantemente una alta eficiencia térmica durante todo el día: mantener limpio el quemador quiere decir reducir tanto el mantenimiento como los gastos de combustible, con una rápida amortización del generador.

Uscite fumi disponibili:
Superiore – posteriore – lato sinistro
Flue outlet options: top-rear-left side



Bruciatore brevettato PelletPower®
PelletPower®
patented burner



• INTEGRA TR-PACK (optional)
Thermocell® (250/400/500 lt);
Thermopuffer (400/500 lt);
Thermosole® (2.0 e 2.6);



• Valvola termostatica a 3 vie
1" FFF 55 OT (optional)
Thermostatic valve 3 ways
1" FFF 55 OT (optional);
Vanne thermostatique 3 voies
1" FFF 55 OT (optional);



• Sonda PT100 (optional - min 2 pz)
per funzione «THERMOCONTROL»
PT100 sensor (optional - min 2 pc)
for «THERMOCONTROL» function
Sonde PT100 (optional - min 2 pces)
pour fonction «THERMOCONTROL»

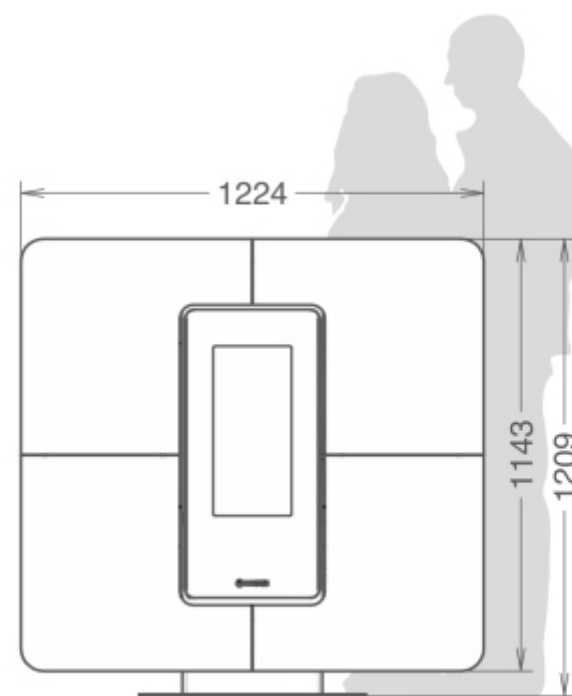

185

1209x1224x316

6 - 21,9

5,8 - 20,5

4,9 - 19,5

1,3 - 4,7

27



PELLETPOWER®
bruciatore brevettato



BellaVista™ R

- ITA** Innovare è rendere semplice un'operazione complessa. Comfort è migliorare la qualità di vita in casa. Sicurezza è prendersi cura dell'ambiente e di chi utilizza i nostri prodotti. Design è lo studio di forme e soluzioni tecnologiche in grado di anticipare i tempi. La ricerca è riunire tutto questo in un solo progetto. Progettata partendo da un nuovo punto di vista il vostro. Disponibile a pellet con tecnologia Silent, Air e Plus.
- DEU** Innovativ bedeutet: Herausforderungen einfach zu lösen. Komfort bedeutet: Lebensqualität zu verbessern. Sicherheit bedeutet: Die Umwelt und die Nutzer des Produktes zu schützen. Design bedeutet: Form und technische Lösungen, die richtungswesend sind. Forschung und Entwicklung: Verbindet all diese Punkte in einem einzigartigen Projekt. Er wurde entwickelt für einen völlig neuen Blickwinkel: Ihren Blickwinkel. Er kann mit der Silent, der Air, oder der Plus Technologie ausgestattet werden.
- ENG** Innovation: it means to simplify an operation hard to do. Comfort: it is the way to improve the quality of living in the home. Safety: it means to take care of the environment and those who use our products. Design: it means to study the form and technological solutions to ensure we are always one-step ahead. Research and Development: it means to take all this and combine together in one unique project. Look far. Designed from a new point of view: yours. Pellet Stove available also with different technology in Silent, Air or Plus version.
- FRA** L'Innovation, c'est rendre simple une opération complexe. Le Confort, c'est améliorer la qualité de vie à la maison. La Sécurité, c'est prendre soin du milieu et de qui utilise nos produits. Le Design, c'est l'étude de formes et solutions technologiques qui nous permettent d'être en avance sur notre temps. La Recherche, c'est réunir tout ceci en un seul projet. Projetée à partir d'un nouveau point de vue: le vôtre. Disponible à granulés, avec technologie Silent, Air ou Plus.
- ESP** Innovar quiere decir simplificar una operación compleja. El Comfort es para mejorar la calidad de vida en el hogar. La Seguridad es el cuidado del medio ambiente y de los que utilizan nuestros productos. El Design es el estudio de formas y soluciones tecnológicas que anticipan a los tiempos. La Investigación es reunir todo esto en un solo proyecto. Thermorossi presenta Bellavista™, la primera estufa de pellets con cristal panorámico que ofrece una intrigante visión a 270° grados de la llama, diseñada a partir de un nuevo punto de vista: el vuestro. Disponible con tecnología de pellets Silent, y Air Plus.



PELLETPOWER®
bruciatore brevettato



2m x 1



• **Thermocomfort (optional)**
Radiocomando con termostato ambiente;
Funksteuerung mit Raumthermostat;
Radio control with room thermostat;
Radiocommande avec thermostat d'ambiance;
Radio control con termostato de ambiente;



• **AIRBOX3 (optional):** riscalda più ambienti,
la stufa diventa ventilata e canalizzabile,
radiocomando in dotazione;
AIRBOX3 (optional): it heats several rooms,
the stove becomes vented and air-ducting, remote
control inclusive as standard;



• **Pietre decorative (optional)**
di colore bianco Carrara o nero ardesia
Decorative stone (optional)
in Carrara white or in slate black colours

Grigio

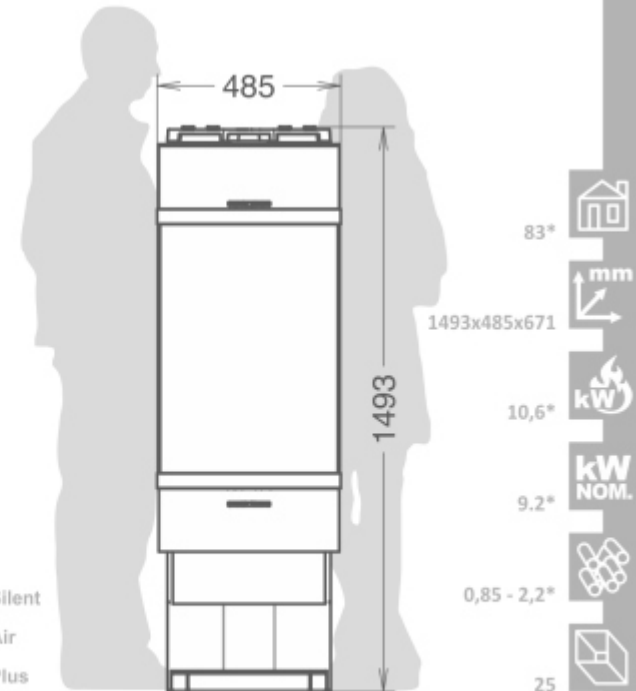

* Dati provvisori in corso di omologazione - * Data under confirmation pending on homologation



MOOD®

- ITA Forme curate, finiture dai forti caratteri materici e raffinate tinte monocromatiche fanno di Mood® una stufa a pellet canalizzabile dal design attuale e contemporaneo concepita per tutti gli spazi, dai piccoli ambienti ai grandi loft. Thermorossi dimostra continuamente la propria attenzione a percorrere nuove vie, con tecniche innovative e un design straordinario in grado di aprire nuovi segmenti di mercato.
- DEU Feine Oberflächen aus robustem Material und raffinierte, harmonische Farben machen Mood®, ein kanalisierbarer Pelletofen mit modernem Design, zu seinem Begleiter in jedem Haus. Er ist sowohl für kleine als auch für mittlere Räumlichkeiten die richtige Wahl. Thermorossi strebt stets und konstant neue Wege an, um immer innovativere und technisch bessere Lösungen mit herausragendem Design anbieten zu können, wodurch neue Marktsegmente erschlossen werden können.
- ENG Meticulous finishes with strong materials and refined monochromatic paints make Mood® an air-ducting pellet stove with a modern design, thought to be suitable for every style of home, from a small house to the spacious loft. Thermorossi assures its constant and continuous attention to pursue new paths, ever innovative, improved technical solutions and outstanding design, in order to open up new segments of the market.
- FRA Des formes soignées, des finitions au caractère fortement matériel, et des teintes monochromes raffinées, font du Mood® un poêle à granulés canalisable au design actuel et contemporain conçu pour tout milieu, de la petite salle au grand loft. Thermorossi démontre continuellement son engagement à parcourir de nouvelles voies, avec des techniques innovantes et un design extraordinaire capables d'ouvrir de nouveaux segments de marché.
- ESP Formas cuidadas, acabados con fuerte carácter artístico y refinados colores monocromos hacen de Mood® una estufa de pellets canalizada de diseño actual y contemporáneo, concebida para todos los entornos, desde la habitación pequeña hasta el gran loft. Thermorossi demuestra continuamente su atención a nuevos enfoques, con técnicas innovadoras y un diseño único que puede abrir nuevos segmentos de mercado.

Una canalizzazione posteriore
One rear hot air ducting outlet

Uscita fumi centrale,
posteriore o superiore
Central flue outlet,
on the rear side or on the top

Piano igienico,
in cristallo con funzione
di scaldia vivande
Practical food warming
plate in hygienic glass

Bruciatore in ghisa
Cast iron burner

L'elegante design rialzato
della base facilita la pulizia
The refined raised base
facilitates the cleaning operations

Schermo comandi programmabile,
con telecomando
Programming control panel,
with remote control

Accesso scorrevole per il
caricamento del pellet
Sliding top access
to the pellet tank

Maniglia removibile.
Essenzialità del design
e maggior sicurezza
Removable door handle.
Essential design and added safety

Design attuale e contemporaneo
grazie ai piedini in pregiato legno
Modern design given by
the feet in high quality wood



• Dinner (optional)
Coperchio scaldia vivande in cristallo;
Warmhalteplatte aus Kristallglas;
Couvercle chauffe-plat en crystal;
Glass food-warming cover;
Chapa para calentar comidas;



• Thermocomfort (optional)
Radiocomando con termostato ambiente;
Funksteuerung mit Raumthermostat;
Radio control with room thermostat;
Radiocommande avec thermostat d'ambiance;
Radio control con termostato de ambiente;



• Tee ridotto per installazione scarico
fumi centrale superiore (optional)
Reduced "T" joint for central upper
smoke extraction outlet (optional)

Grigio

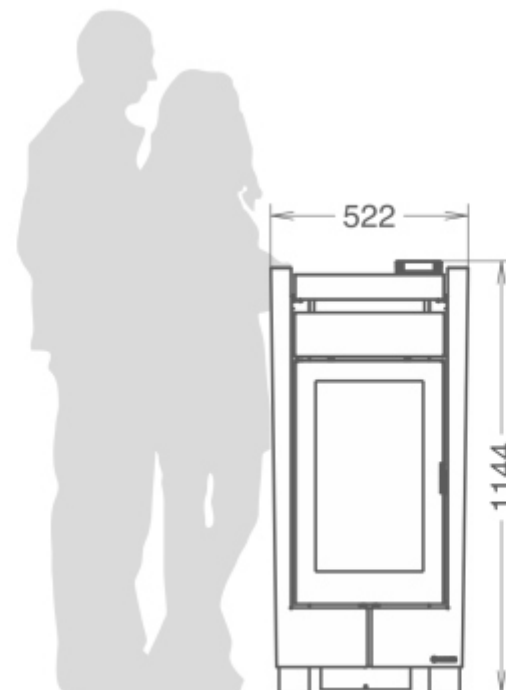

83

mm

1144x522x554

3 - 10,2

kW NOM.

0,7 - 2,3

16



15m x 1



KOKKOLA®

- ITA Kokkola® risponde al bisogno innato di sentirsi amati e protetti, il fuoco viene accarezzato e diventa il perfetto equilibrio tra calore e comfort. Per tutte le abitazioni di campagna e città, al mare ed in montagna Kokkola® è la stufa a pellet canalizzabile che arreda con eleganza grazie ai delicati colori ed alla qualità della lavorazione. Alcuni ricercati dettagli come l'alternanza dei materiali utilizzati, che vanno dalla ghisa alle pregiate maioliche lavorate a mano, rendono il design di Kokkola® prestigioso e raffinato. La predisposizione per lo scarico fumi centrale e superiore, assieme al pratico accesso al serbatoio attraverso lo scorrimento del coperchio in ghisa danno un tocco di contemporaneità ad uno stile tradizionale.
- DEU Kokkola® erfüllt das natürliche Bedürfnis von sich geliebt und beschützt zu fühlen; die tanzenden Flammen sind die perfekte Balance von Wärme und Komfort. Egal ob für ein Haus in der Stadt oder auf dem Land, am Meer oder in den Bergen, Kokkola® ist der kanalisierbare Pelletofen, der Ihr Zuhause mit Eleganz, zarter Blumen-Dekoration und hochwertiger Verarbeitung aufwertet. Wertvolle Details aus Gußeisen oder die exklusive handgefertigte Keramik machen das Design von Kokkola® raffiniert und elegant. Die Möglichkeit für eine mittige Rauchrohrführung in Verbindung mit dem innovativen Gußeisen Schiebemechanismus zum Befüllen des Pellettanks bringt einen zusätzlichen Hauch von moderner Technik welcher sich mit dem traditionellen Stil des Ofens verbindet.
- ENG Kokkola® satisfies the natural need to feel loved and protected; the dancing flames are the perfect balance of warmth and comfort. For houses in cities or in the countryside, near the sea or in the mountains, Kokkola® is the air-ducting pellet stove that furnishes your home with elegance, having delicate flowers decorations and high quality manufacturing. Some precious details like materials used, from cast iron to precious ceramics handmade by master craftsmen, make the design of Kokkola® very refined and elegant. The predisposition for the top central smoke outlet, together with the innovative cast iron sliding top access to the pellet tank bring a touch of contemporary to the traditional style.
- FRA Le Kokkola® répond au besoin inné de se sentir aimés et protégés ; le feu vous caresse et forme l'équilibre parfait entre chaleur et confort. Pour tous les types d'habitations, à la campagne et en ville, à la mer et en montagne, le Kokkola® est le poêle à granulés canalisable qui meuble avec élégance, grâce à ses couleurs délicates et à la qualité de sa réalisation. Les détails recherchés, comme l'alternance des matériaux utilisés, de la fonte aux précieuses céramiques faites à la main, rendent le design du Kokkola® prestigieux et raffiné. La prédisposition pour la sortie des fumées centrale et supérieure, et l'accès pratique au réservoir à granulés par coulissement du couvercle en fonte, donnent une touche de contemporanéité à un style traditionnel.
- ESP Kokkola® responde a la necesidad innata de sentirse queridos y protegidos, el fuego se acaricia y se convierte en el perfecto equilibrio de calor y confort. Para todas las viviendas de campo, en ciudad, al mar y a la montaña, Kokkola® es una estufa de pellets canalizada que decora con elegancia gracias a sus colores delicados y a la alta calidad de fabricación. Algunos detalles sofisticados, como la alternancia de los materiales utilizados, de la fundición hasta las preciosas mayólicas hechas a mano, hacen del diseño de Kokkola® algo prestigioso y refinado. La predisposición a la salida de humos central y superior, junto al cómodo acceso al depósito a través de la tapa retráctil en fundición le dan un toque contemporáneo a su estilo tradicional.

Una canalizzazione posteriore
One rear hot air ducting outlet

Uscita fumi centrale,
posteriore o superiore
Central flue outlet,
on the rear side or on the top

Schermo comandi programmabile,
con telecomando
Programming control panel,
with remote control

Preziosa maiolica artigianale
fatta a mano
Precious handmade majolica
by master craftsmen

Coperchio superiore in ghisa con accesso
scorrevole per il caricamento del pellet
Cast iron sliding top access to the pellet tank

Maniglia removibile.
Essenzialità del design e maggior sicurezza
Removable door handle
Essential design and added safety

Bruciatore in ghisa
Cast iron burner

L'elegante design rialzato
della base facilita la pulizia
The refined raised base
facilitates the cleaning operations



• Thermocomfort (optional)
Radiocomando con termostato ambiente;
Funksteuerung mit Raumthermostat;
Radio control with room thermostat;
Radiocommande avec thermostat d'ambiance;
Radio control con termostato de ambiente;



• Tee ridotto per installazione scarico
fumi centrale superiore (optional)
Reduced "T" joint for central upper
smoke extraction outlet (optional)

Bianco

Beige

Tortora

Cuocio

Bordeaux

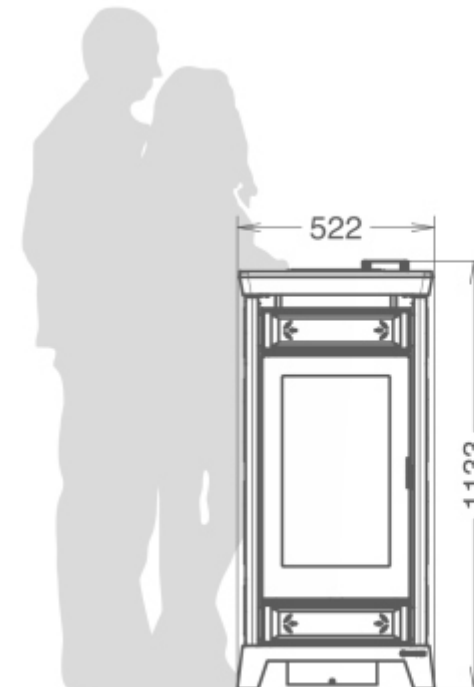

83

mm

1133x522x577

3 - 10,2

2,5 - 9,2

0,7 - 2,3

16



15m^{x1}



5000 metalcolor

ITA Il colore grigio antracite e le finiture curate permettono di integrare Easy in qualsiasi ambiente.

DEU Mit seiner anthrazitgrauen Farbe und den sorgfältig verarbeiteten Reliefflächen fügt sich Easy problemlos in jede Umgebung ein

ENG Its anthracite grey colour and its meticulous finish with bas-relief details make it the perfect unit for any room

FRA Grâce à sa couleur gris anthracite et à ses finitions soignées, l'Easy peut être intégré dans n'importe quel milieu

ESP El color gris antracita y los esmerados acabados con especiales mecanizaciones en bajo relieve permiten integrar Easy en cualquier ambiente

Canalizzazioni disponibili:
due uscite posteriori
Duct vents options: two rear

Schermo comandi programmabile,
con telecomando
Programming control panel,
with remote control



• Thermocomfort (optional)
Radiocomando con termostato ambiente;
Funksteuerung mit Raumthermostat;
Radio control with room thermostat;
Radiocommande avec thermostat d'ambiance;
Radio control with thermostat de ambiente;

Bianco



Beige



Cuoio



Bordeaux



Grigio



Maiolica nera
e Inox



Bruciatore in ghisa
Cast iron burner

Porta in ghisa
Cast iron firebox door

Ampio cassetto cenere
estraibile
Removable spacious
ash tray

Maniglia antiscottatura
Anti-burn door handle

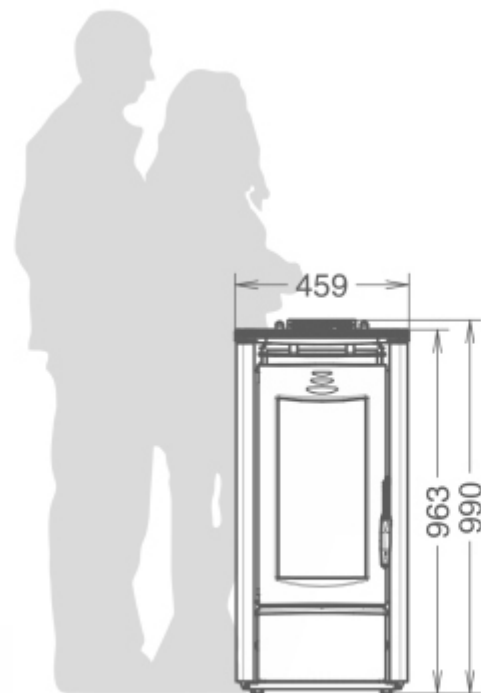

83



mm

990x459x577



3,0 - 10,2



kW
NOM.

0,7 - 2,3



14,5



15m^{x1}
5m^{x2}

5000 maiolica

ITA Finiture curate e pregiate maioliche arricchiscono l'ampia visione del focolare

DEU Oberflächen und kostbare Majolika bereichern die globale Vision der Feuerraum

ENG Painstaking trimmings and valuable majolica enrich the vision of fire pot

FRA Finitions soignées et précieuses faïences enrichissent la vision globale du foyer

ESP Cuidados acabados y apreciables mayólica enriquecen la vision de la llama

Canalizzazioni disponibili:
due uscite posteriori
Duct vents options: two rear



• Thermocomfort (optional)
Radiocomando con termostato ambiente;
Funksteuerung mit Raumthermostat;
Radio control with room thermostat;
Radiocommande avec thermostat d'ambiance;
Radio control con termostato de ambiente;

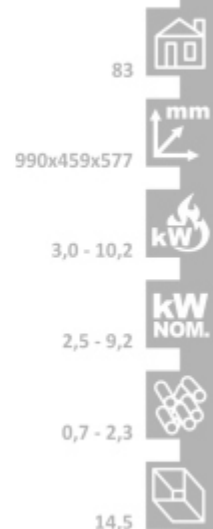
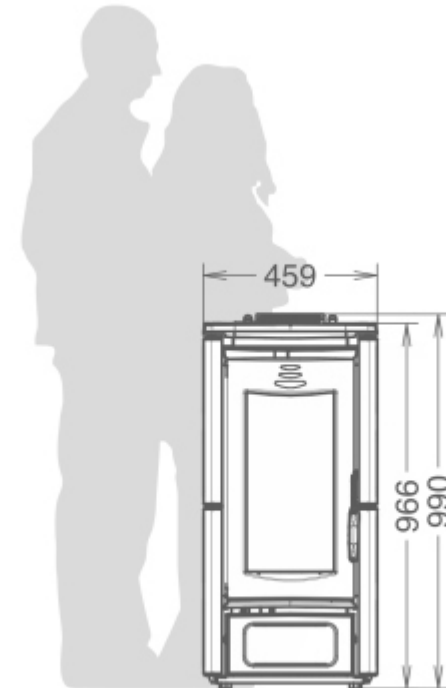

15m^x1
5m^x2

silent - air - plus - idra



DORICA metalcolor

ITA Stufa a pellet dalle linee fluide e raccordate, sorprende al primo sguardo per la sua elegante architettura ispirata alla classicità. Dotata di bruciatore motorizzato con tecnologia PELLETPOWER® (modello Idra), scambiatore di calore THERMOCORE® e pulizia ordinaria e straordinaria semplificata EASY CLEANING. Disponibile nella versione Silent, Air, Plus e Idra.

DEU Ausgestattet mit fließenden Linien ist dieser Pelletofen auf den ersten Blick sehr anmutend und überrascht mit einem eleganten Design, das seinesgleichen sucht. Auch eine klassische Erscheinung mit Keramikverkleidung ist möglich. Ausgestattet mit einem Raumluftventilator, mit der PELLETPOWER® Technologie (nur Idra), dem Wärmetauscher THERMOCORE® und dem einfachen EASY CLEANING Reinigungssystem. Verfügbar in den Versionen Silent, Air, Plus und Idra.

ENG Pellet stove with flowing and joined lines, it is surprising at first sight for its elegant architecture inspired by the classics. Equipped with the motorised fan technology PELLETPOWER® (Idra model) heat exchanger THERMOCORE® and simplified cleaning system EASY CLEANING. Available in versions, Silent, Air, Plus and Idra.

FRA Poêle à granules aux lignes fluides et raccordées, qui surprend au premier coup d'œil par son architecture élégante, inspirée au classicisme. Doté du brûleur motorisé avec technologie PELLETPOWER® (version Idra), de l'échangeur de chaleur THERMOCORE®, et du système de nettoyage ordinaire et extraordinaire simplifié EASY CLEANING. Disponible dans les versions Silent, Air, Plus et Idra.

ESP Estufa de pellets con líneas fluidas y refinadas, que destaca a primera vista por su arquitectura elegante de inspiración clásica. Equipada con la tecnología de quemador motorizado, PELLETPOWER® (versión Idra), intercambiador de calor THERMOCORE® y limpieza ordinaria y extraordinaria simplificadas EASY CLEANING. Disponible en versión Silent Air, Idra y Plus.



Porta focolare in vetro
ceramico serigrafato e ghisa
Cast iron and glass
firebox door

Piano salva cenere
Ash collecting base

Preziosa maiolica artigianale
fatta a mano
Precious handmade majolica
by master craftsmen



Di serie su termostufe versione «Idra»
Standard on thermo-stoves "Idra" version

														Silent
														Air
														Plus
														Idra

** Non disponibile per versione «Silent» e «Idra»
** Not available on "Silent" and "Idra" versions

*** Non disponibile per versione «Idra»
*** Not available on "Idra" version

**** Solo versione «Idra»
**** Only on "Idra" version

La tipologia di fiamma ed il focolare possono variare a seconda delle versioni
Flame and the firebox can vary according to different model



• Dinner** (optional)
Coperchio scalda vivande in cristallo;
Warmhalteplatte aus Kristallglas;
Couvercle chauffe-plat en crystal;
Glass food-warming cover;
Chapa para calentar comidas;



• Thermocomfort*** (optional)
Radiocomando con termostato ambiente;
Funksteuerung mit Raumthermostat;
Radio control with room thermostat;
Radiocommande avec thermostat d'ambiance;
Radio control con termostato de ambiente;



• INTEGRA TR-PACK**** (optional)
Thermocell® (400 o 500 lt)
Thermopuffer (400 o 500 lt)
Thermosole® (2.0 e 2.6)



• External primary air input (optional)
Input esterno dell'aria primaria;
Eintritt der primäre Luft vom außen;
External primary air input;
Entrée d'air primaire externe;
Entrada externa de aire primario;

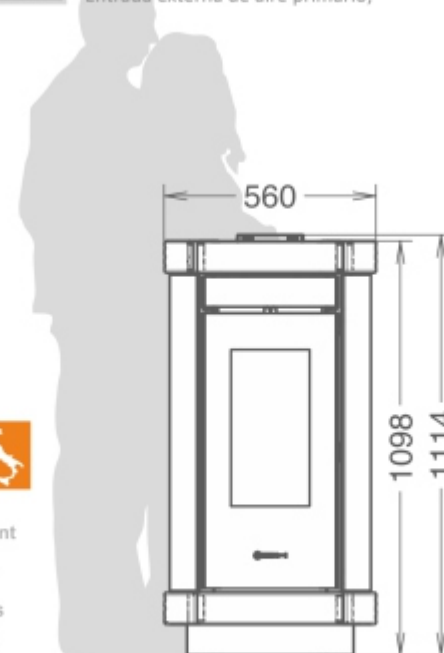

1114x560x645

Silent 4 - 9,3
Air 4,8 - 13,2
Plus 4,8 - 13,2
Idra 3,8 - 13,5

Silent 3,4 - 8
Air 4,3 - 11,4
Plus 4,3 - 11,4
Idra 3,5 - 12,2

Silent 0,8 - 1,9
Air 1 - 2,7
Plus 1 - 2,7
Idra 0,8 - 2,9

Silent 19
Air 19
Plus 15
Idra 19



silent - air - plus - idra



DORICA maiolica

- ITA Stufa a pellet dalle linee fluide e raccordate, sorprende al primo sguardo per la sua elegante architettura ispirata alla classicità. Dotata di bruciatore motorizzato con tecnologia PELLETPOWER® (modello Idra), scambiatore di calore THERMOCORE® e pulizia ordinaria e straordinaria semplificata EASY CLEANING. Disponibile nella versione Silent, Air, Plus e Idra.
- DEU Ausgestattet mit fließenden Linien ist dieser Pelletofen auf den ersten Blick sehr anmutend und überrascht mit einem eleganten Design, dass seinesgleichen sucht. Auch eine klassische Erscheinung mit Keramikverkleidung ist möglich. Ausgestattet mit einem Raumluftventilator, mit der PELLETPOWER® Technologie (nur Idra), dem Wärmetauscher THERMOCORE® und dem einfachen EASY CLEANING Reinigungssystem. Verfügbar in den Versionen Silent, Air und Idra.
- ENG Pellet stove with flowing and joined lines, it is surprising at first sight for its elegant architecture inspired by the classics. Equipped with the motorised fan technology PELLETPOWER® (Idra model) heat exchanger THERMOCORE® and simplified cleaning system EASY CLEANING. Available in versions, Silent, Air, Plus and Idra.
- FRA Poêle à granulés aux lignes fluides et raccordées, qui surprend au premier coup d'œil par son architecture élégante, inspirée au classicisme. Doté du brûleur motorisé avec technologie PELLETPOWER® (version Idra), de l'échangeur de chaleur THERMOCORE®, et du système de nettoyage ordinaire et extraordinaire simplifié EASY CLEANING. Disponible dans les versions Silent, Air, Plus et Idra.
- ESP Estufa de pellets con líneas fluidas y refinadas, que destaca a primera vista por su arquitectura elegante de inspiración clásica. Equipada con la tecnología de quemador motorizado, PELLETPOWER® (versión Idra), intercambiador de calor THERMOCORE® y limpieza ordinaria y extraordinaria simplificadas EASY CLEANING. Disponible en versión Silent Air, Idra y Plus.

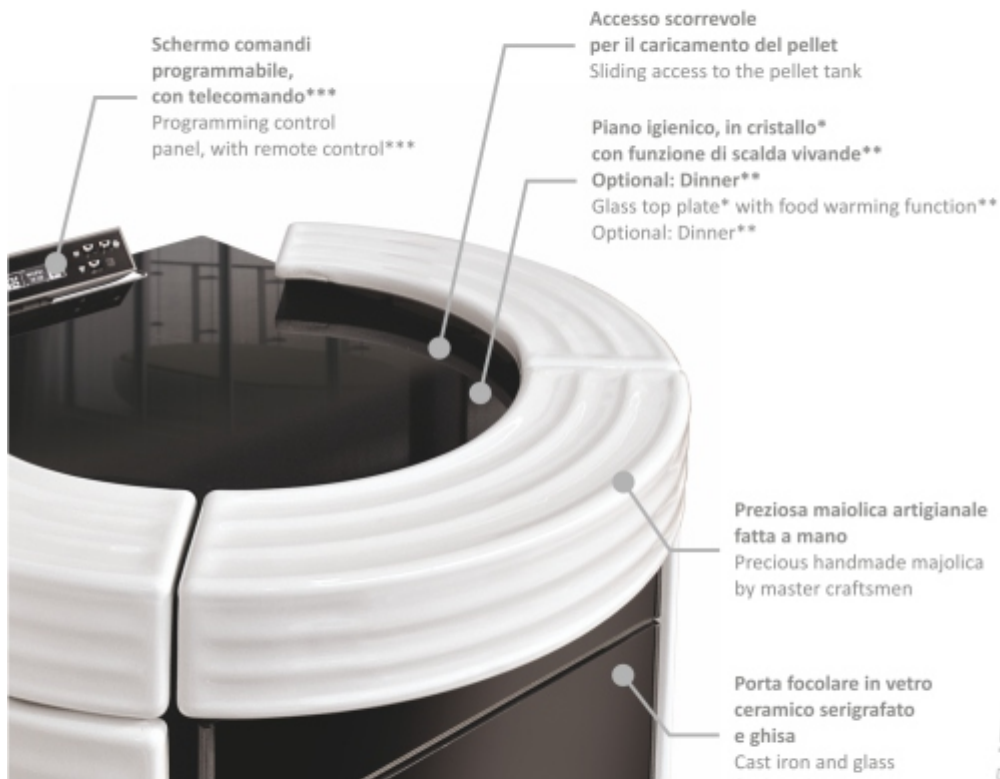

• Dinner** (optional)
Coperchio scaldare vivande in cristallo;
Glass food-warming cover;
Couvercle chauffe-plat en crystal;
Warmhalteplatte aus Kristallglas;
Chapa para calentar comidas;



• Thermocomfort*** (optional)
Radiocomando con termostato ambiente;
Funksteuerung mit Raumthermostat;
Radio control with room thermostat;
Radiocommande avec thermostat d'ambiance;
Radio control con termostato de ambiente;



• INTEGRA TR-PACK**** (optional)
Thermocell® (400 o 500 lt)
Thermopuffer (400 o 500 lt)
Thermosole® (2.0 e 2.6)



• External primary air input (optional)
Input esterno dell'aria primaria;
Eintritt der primäre Luft vom außen;
External primary air input;
Entrée d'air primaire externe;
Entrada externa de aire primario;

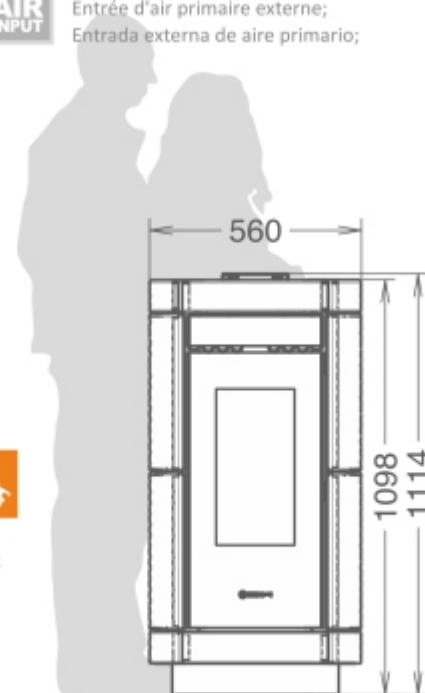

1114x560x645

Silent 4 - 9,3
Air 4,8 - 13,2
Plus 4,8 - 13,2
Idra 3,8 - 13,5

Silent 3,4 - 8
Air 4,3 - 11,4
Plus 4,3 - 11,4
Idra 3,5 - 12,2

Silent 0,8 - 1,9
Air 1 - 2,7
Plus 1 - 2,7
Idra 0,8 - 2,9

Silent 19
Air 19
Plus 15
Idra 19

											Silent
											Air
											Plus
											Idra

* Non disponibile per versione «Silent»
* Not available on "Silent" version

** Non disponibile per versione «Silent» e «Idra»
** Not available on "Silent" and "Idra" versions

*** Non disponibile per versione «Idra»
*** Not available on "Idra" version

**** Solo versione «Idra»
**** Only on "Idra" version

La tipologia di fiamma ed il focolare possono variare a seconda delle versioni
Flame and the firebox can vary according to different model

silent - air - plus - idra



AROMY^{metalcolor}

- ITA Stufa a pellet dal design essenziale e minimalista, rivestita in pietra ollare oppure in acciaio colorato arricchita da una maiolica per diffondere essenze aromatiche. Dotata di bruciatore motorizzato con tecnologia PELLETPOWER® (modello Idra), scambiatore di calore THERMOCORE® e pulizia ordinaria e straordinaria semplificata EASY CLEANING. Disponibile nella versione Silent, Air, Plus e Idra.
- DEU Der Pelletofen mit geradlinigem und minimalistischem Design, verkleidet mit Sandstein oder farbigen Stahl und einer Duftschale für aromatische Raumduftöle, wird Sie begeistern. Ausgestattet mit einem Raumlüftventilator, mit der PELLETPOWER® Technologie (nur Idra), dem Wärmetauscher THERMOCORE® und dem einfachen EASY CLEANING Reinigungssystem. Verfügbar in den Versionen Silent, Air, Plus und Idra.
- ENG Pellet stove with an essential and minimalist design, clad in soapstone or coloured steel embellished with aromatic essential oils. Equipped with the motorised fan technology PELLETPOWER® (Idra model) heat exchanger THERMOCORE® and simplified cleaning system EASY CLEANING. Available in versions, Silent, Air, Plus and Idra.
- FRA Poêle à granulés au design essentiel et minimaliste, habillé en pierre ollaire ou en acier coloré, enrichi d'une céramique pour la diffusion d'essences aromatiques. Doté du brûleur motorisé avec technologie PELLETPOWER® (version Idra), de l'échangeur de chaleur THERMOCORE®, et du système de nettoyage ordinaire et extraordinaire simplifié EASY CLEANING. Disponible dans les versions Silent, Air, Plus et Idra.
- ESP Estufa de pellets de diseño esencial y minimalista, con acabados en piedra o en acero enriquecido por elementos en cerámica para emanar esencias aromáticas. Equipada con la tecnología de quemador motorizado PELLETPOWER® (versión Idra), intercambiador de calor THERMOCORE® y limpieza ordinaria y extraordinaria simplificadas EASY CLEANING. Disponible en versión Silent Air, Idra y Plus.

Schermo comandi programmabile,
con telecomando***
Programming control panel,
with remote control***

Accesso scorrevole
per il caricamento del pellet
Sliding access to the pellet tank

Piano igienico, in cristallo*
con funzione di scaldare vivande**
Optional: Dinner**
Glass top plate*
with food warming function**
Optional: Dinner**

Maniglia diffondi aromi
in preziosa ceramica
Precious ceramic handle
with aroma diffuser

Porta focolare in vetro
ceramico serigrafato
e ghisa
Cast iron and glass
firebox door

Maniglia removibile. Essenzialità nel design
e maggior sicurezza
Removable door handle. Essential design
and high safety

Piano salva cenere
Ash collecting base



• Dinner** (optional)
Coperchio scaldare vivande in cristallo;
Warmhalteplatte aus Kristallglas;
Couvercle chauffe-plat en crystal;
Glass food-warming cover;
Chapa para calentar comidas;



• Thermocomfort*** (optional)
Radiocomando con termostato ambiente;
Funksteuerung mit Raumthermostat;
Radio control with room thermostat;
Radiocommande avec thermostat d'ambiance;
Radio control con termostato de ambiente;



• INTEGRA TR-PACK**** (optional)
Thermocell® (400 o 500 lt)
Thermopuffer (400 o 500 lt)
Thermosole® (2.0 e 2.6)



• External primary air input (optional)
Input esterno dell'aria primaria;
Eintritt der primäre Luft vom außen;
External primary air input;
Entrée d'air primaire externe;
Entrada externa de aire primario;

Bianco

Tortora

Grigio

Bordeaux

Ruggine

Nero - Bronze

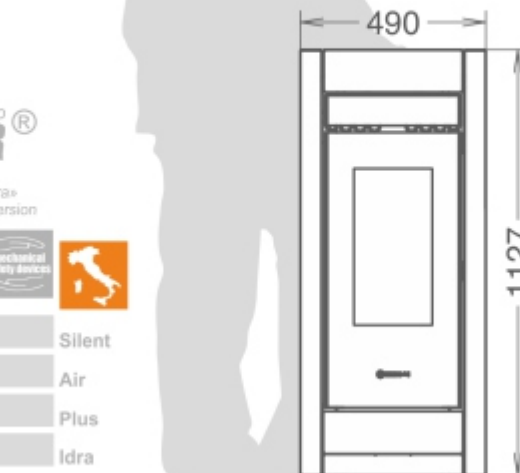

1127x490x596

Silent 4 - 9,3
Air 4,8 - 13,2
Plus 4,8 - 13,2
Idra 3,8 - 13,5

Silent 3,4 - 8
Air 4,3 - 11,4
Plus 4,3 - 11,4
Idra 3,5 - 12,2

Silent 0,8 - 1,9
Air 1 - 2,7
Plus 1 - 2,7
Idra 0,8 - 2,9

Silent 19
Air 15
Plus 15
Idra 19

bruciatore brevettato
PELLETPOWER®

Di serie su termostato versione «Idra»
Standard on thermo-stoves "Idra" version

													Silent
													Air
													Plus
													Idra

* Non disponibile per versione «Silent»
* Not available on "Silent" version

** Non disponibile per versione «Silent» e «Idra»
** Not available on "Silent" and "Idra" versions

*** Non disponibile per versione «Idra»
*** Not available on "Idra" version

**** Solo versione «Idra»
**** Only on "Idra" version

La tipologia di fiamma ed il focolare possono variare a seconda delle versioni
Flame and the firebox can vary according to different model

silent - air - plus - idra



AROMY^{stone}

- ITA** Stufa a pellet dal design essenziale e minimalista, rivestita in pietra ollare oppure in acciaio colorato arricchita da una maiolica per diffondere essenze aromatiche. Dotata di bruciatore motorizzato con tecnologia PELLETPOWER® (modello Idra), scambiatore di calore THERMOCORE® e pulizia ordinaria e straordinaria semplificata EASY CLEANING. Disponibile nella versione Silent, Air, Plus e Idra.
- DEU** Der Pelletofen mit geradlinigem und minimalistischem Design, verkleidet mit Sandstein oder farbigen Stahl und einer Duftschale für aromatische Raumduftöle, wird Sie begeistern. Ausgestattet mit einem Raumlüftventilator, mit der PELLETPOWER® Technologie (nur Idra), dem Wärmetauscher THERMOCORE® und dem einfachen EASY CLEANING Reinigungssystem. Verfügbar in den Versionen Silent, Air, Plus und Idra.
- ENG** Pellet stove with an essential and minimalist design, clad in soapstone or coloured steel embellished with aromatic essential oils. Equipped with the motorised fan technology PELLETPOWER® (Idra model) heat exchanger THERMOCORE® and simplified cleaning system EASY CLEANING. Available in versions, Silent, Air, Plus and Idra.
- FRA** Poêle à granulés au design essentiel et minimaliste, habillé en pierre ollaire ou en acier coloré, enrichi d'une céramique pour la diffusion d'essences aromatiques. Doté du brûleur motorisé avec technologie PELLETPOWER® (version Idra), de l'échangeur de chaleur THERMOCORE®, et du système de nettoyage ordinaire et extraordinaire simplifié EASY CLEANING. Disponible dans les versions Silent, Air, Plus et Idra.
- ESP** Estufa de pellets de diseño esencial y minimalista, con acabados en piedra o en acero enriquecido por elementos en cerámica para emanar esencias aromáticas. Equipada con la tecnología de quemador motorizado PELLETPOWER® (versión Idra), intercambiador de calor THERMOCORE® y limpieza ordinaria y extraordinaria simplificadas EASY CLEANING. Disponible en versión Silent, Air, Idra y Plus.

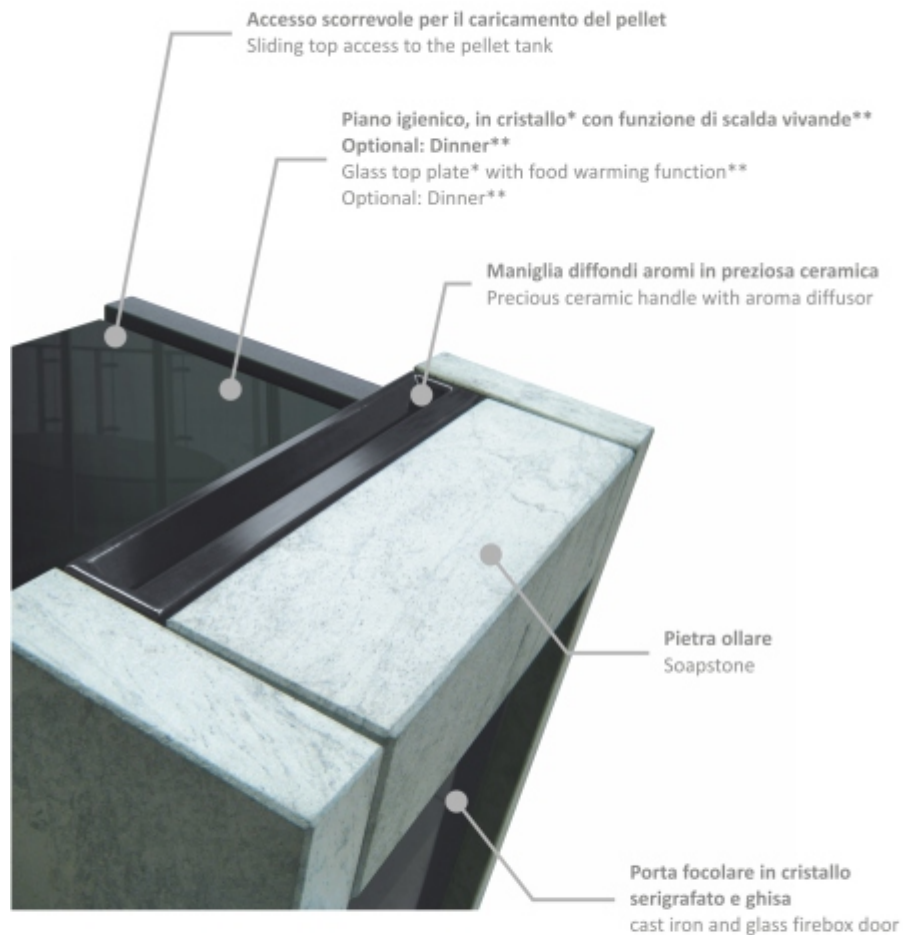

															Silent
															Air
													15m 5m		Plus
															Idra

* Non disponibile per versione «Silent»
* Not available on "Silent" version

** Non disponibile per versione «Silent» e «Idra»
** Not available on "Silent" and "Idra" versions

*** Non disponibile per versione «Idra»
*** Not available on "Idra" version

**** Solo versione «Idra»
**** Only on "Idra" version



• Dinner** (optional)
Coperchio scaldia vivande in cristallo;
Warmhalteplatte aus Kristallglas;
Couverture chauffe-plat en crystal;
Glass food-warming cover;
Chapa para calentar comidas;



• Thermocomfort*** (optional)
Radiocomando con termostato ambiente;
Funksteuerung mit Raumthermostat;
Radio control with room thermostat;
Radiocommande avec thermostat d'ambiance;
Radio control con termostato de ambiente;



• INTEGRA TR-PACK**** (optional)
Thermocell® (400 o 500 lt)
Thermopuffer (400 o 500 lt)
Thermosole® (2.0 e 2.6)



• External primary air input (optional)
Input esterno dell'aria primaria;
Eintritt der primäre Luft vom außen;
External primary air input;
Entrée d'air primaire externe;
Entrada externa de aire primario;

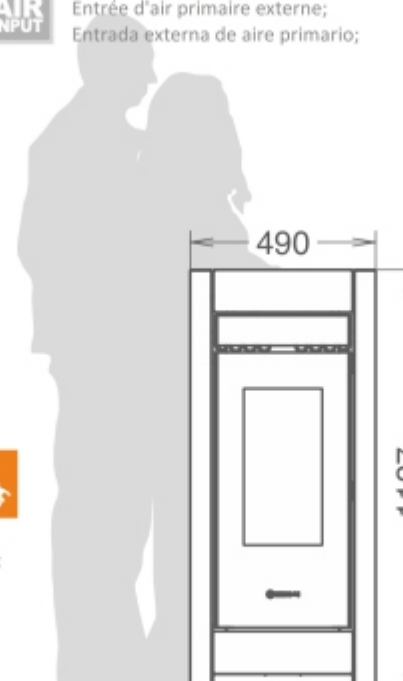

1127x490x596

Silent 4 - 9,3
Air 4,8 - 13,2
Plus 4,8 - 13,2
Idra 3,8 - 13,5

Silent 3,4 - 8
Air 4,3 - 11,4
Plus 4,3 - 11,4
Idra 3,5 - 12,2

Silent 0,8 - 1,9
Air 1 - 2,7
Plus 1 - 2,7
Idra 0,8 - 2,9

Silent 19
Air 19
Plus 15
Idra 19

Ollare



La tipologia di fiamma ed il focolare possono variare a seconda delle versioni
Flame and the firebox can vary according to different model

silent - air - plus - idra



SAINT MORITZ

- ITA Stile ed eleganza arricchita da preziose maiolica fatte a mano con pregiate lavorazioni in sottorilievo. Dotata di bruciatore motorizzato con tecnologia PELLETPOWER® (modello Idra), scambiatore di calore THERMOCORE® e pulizia ordinaria e straordinaria semplificata EASY CLEANING. Disponibile nella versione Silent, Air, Plus e Idra.
- DEU Stil und Eleganz angereichert mit wertvoller handgemachter Keramik mit feiner Verarbeitung und Reliefprägung. Ausgestattet mit einem Raumluftventilator, mit der PELLETPOWER® Technologie (nur Idra), dem Wärmetauscher THERMOCORE® und dem einfachen EASY CLEANING Reinigungssystem. Verfügbar in den Versionen Silent, Air, Plus und Idra.
- ENG Style and elegance enriched by precious majolica handmade with fine workmanship in relief. Equipped with the motorised fan technology PELLETPOWER® (Idra model) heat exchanger THERMOCORE® and simplified cleaning system EASY CLEANING. Available in versions, Silent, Air, Plus and Idra.
- FRA Style et élégance, enrichis de précieuses céramiques faites à la main, avec de remarquables détails en bas-relief. Doté du brûleur motorisé avec technologie PELLETPOWER® (version Idra), de l'échangeur de chaleur THERMOCORE®, et du système de nettoyage ordinaire et extraordinaire simplifié EASY CLEANING. Disponible dans les versions Silent, Air, Plus et Idra.
- ESP Estilo y elegancia enriquecidos por preciosas cerámicas hechas a mano con acabados en bajo relieve. Equipada con la tecnología de quemador motorizado PELLETPOWER® (versión Idra), intercambiador de calor THERMOCORE® y limpieza ordinaria y extraordinaria simplificadas EASY CLEANING. Disponible en versión Silent Air, Idra y Plus.

Schermo comandi programmabile,
con telecomando***
Programming control panel,
with remote control***

Accesso scorrevole
per il caricamento del pellet
Sliding top access to the pellet tank

Piano igienico, in cristallo*
con funzione di scaldare vivande**
Optional: Dinner**
Glass top plate* with food warming function**
Optional: Dinner**

Preziosa maiolica artigianale
fatta a mano
Precious handmade majolica
by master craftsmen

Porta focolare in vetro
ceramico serigrafato e ghisa
Cast iron and glass firebox door



• Dinner** (optional)
Coperchio scaldare vivande in cristallo;
Warmhalteplatte aus Kristallglas;
Couvercle chauffe-plat en crystal;
Glass food-warming cover;
Chapa para calentar comidas;



• Thermocomfort*** (optional)
Radiocomando con termostato ambiente;
Funksteuerung mit Raumthermostat;
Radio control with room thermostat;
Radiocommande avec thermostat d'ambiance;
Radio control con termostato de ambiente;



• INTEGRA TR-PACK**** (optional)
Thermocell® (400 o 500 lt)
Thermopuffer (400 o 500 lt)
Thermosole® (2.0 e 2.6)



• External primary air input (optional)
Input esterno dell'aria primaria;
Eintritt der primäre Luft vom außen;
External primary air input;
Entrée d'air primaire externe;
Entrada externa de aire primario;

- Bianco
- Beige
- Tortora
- Bordeaux
- Bianco Beige
- Bianco Tortora
- Bianco Bordeaux

bruciatore brevettato
PELLETPOWER®
Di serie su termostufe versione «Idra»
Standard on thermo-stoves "Idra" version

														Silent
														Air
												15m 5m		Plus
														Idra

* Non disponibile per versione «Silent»
* Not available on "Silent" version

** Non disponibile per versione «Silent» e «Idra»
** Not available on "Silent" and "Idra" versions

*** Non disponibile per versione «Idra»
*** Not available on "Idra" version

**** Solo versione «Idra»
**** Only on "Idra" version

La tipologia di fiamma ed il focolare possono variare a seconda delle versioni
Flame and the firebox can vary according to different model

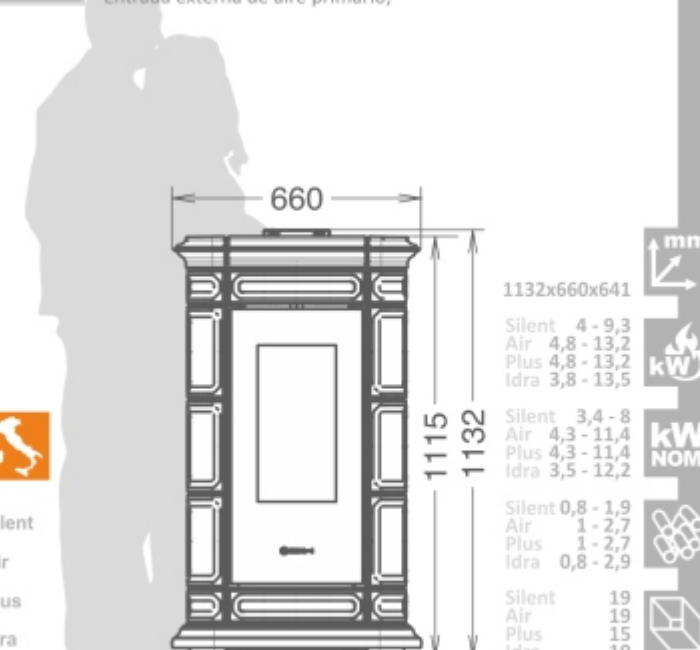

LIENZ



ITA Il fascino intramontabile di una stufa rivestita in pregiata maiolica lavorata a mano da maestri artigiani, di serie un pratico vano scaldavivande a scomparsa in cristallo e maiolica. Dotata di bruciatore motorizzato con tecnologia PELLETPOWER® (modello Idra), scambiatore di calore THERMOCORE® e pulizia ordinaria e straordinaria semplificata EASY CLEANING. Disponibile nella versione Air, Plus e Idra.

DEU Die zeitlose Erscheinung eines Ofens mit einer Verkleidung aus feiner Keramik, hergestellt aus Meisterhand, kombiniert mit einem ausziehbaren Warmhaltefach, gibt einen ganz besonderen Charme. Ausgestattet mit einem Raumlüftventilator, mit der PELLETPOWER® Technologie (nur Idra), dem Wärmetauscher THERMOCORE® und dem einfachen EASY CLEANING Reinigungssystem. Verfügbar in den Versionen Air, Plus und Idra.

ENG The timeless appeal of a stove covered with fine majolica hand-made by master craftsmen, a practical hot plate covered by retractable glass and earthenware. Equipped with the motorised fan technology PELLETPOWER® (Idra model) heat exchanger THERMOCORE® and simplified cleaning system EASY CLEANING. Available in versions Air, Plus and Idra.

FRA Le charme indémodable d'un poêle revêtu de précieuses céramiques faites à la main par des maîtres-artisans, surmonté d'un tiroir-chauffe-plats pratique, en cristal et céramique. Doté du brûleur motorisé avec technologie PELLETPOWER® (version Idra), de l'échangeur de chaleur THERMOCORE®, et du système de nettoyage ordinaire et extraordinaire simplifié EASY CLEANING. Disponible dans les versions Air, Plus et Idra.

ESP El eterno atractivo de una estufa revestida con fina mayólica hecha a mano por maestros artesanos, ofrece un práctico hueco retráctil para calentar comidas en cristal y cerámica. Equipada con la tecnología de quemador motorizado PELLETPOWER® (versión Idra), intercambiador de calor THERMOCORE® y limpieza ordinaria y extraordinaria simplificadas EASY CLEANING. Disponible en versión Air, Idra y Plus.



Vano scalda vivande*
(con piano igienico in cristallo)
Food warming cover*
(with hygienic glass base)

Preziosa maiolica artigianale
fatta a mano
Precious handmade majolica
by master craftsmen

Porta focolare in vetro
serigrafato e ghisa
Cast iron and glass
firebox door



													Air
													Plus
													Idra

* Non disponibile per versione «Idra»
* Not available on "Idra" version

** Solo versione «Idra»
** Only on "Idra" version

La tipologia di fiamma ed il focolare possono variare a seconda delle versioni
Flame and the firebox can vary according to different model



• **Thermocomfort* (optional)**
Radiocomando con termostato ambiente;
Funksteuerung mit Raumthermostat;
Radio control with room thermostat;
Radiocommande avec thermostat d'ambiance;
Radio control con termostato de ambiente;



• **INTEGRA TR-PACK** (optional)**
Thermocell® (400 o 500 lt)
Thermopuffer (400 o 500 lt)
Thermosole® (2.0 e 2.6)



• **External primary air input (optional)**
Input esterno dell'aria primaria;
Eintritt der primäre Luft vom außen;
External primary air input;
Entrée d'air primaire externe;
Entrada externa de aire primario;

- Bianco
- Beige
- Tortora
- Bordeaux
- Bianco Beige
- Bianco Tortora
- Bianco Bordeaux



1323x660x641

Air 4,8 - 13,2
Plus 4,8 - 13,2
Idra 3,8 - 13,5

Air 4,3 - 11,4
Plus 4,3 - 11,4
Idra 3,5 - 12,2

Air 1 - 2,7
Plus 1 - 2,7
Idra 0,8 - 2,9

Air 19
Plus 15
Idra 19

mm

kW

kW
NOM.



MONTREUX

- ITA Raffinata eleganza in stile romantico, per tutti coloro che amano circondarsi da preziosi complementi d'arredo. Montreux rappresenta la massima espressione di cura del dettaglio dal prezioso fregio floreale lavorato a mano al pratico vano scaldavivande in cristallo e maiolica. Dotata di bruciatore motorizzato con tecnologia PELLETPOWER® (modello Idra), scambiatore di calore THERMOCORE® e pulizia ordinaria e straordinaria semplificata EASY CLEANING. Disponibile nella versione Air, Plus e Idra.
- DEU Raffinierte Eleganz gepaart mit romantischem Stil, so präsentiert sich dieser Pelletofen all jenen, die sich gerne mit edlen Objekten umgeben. Montreux ist der ultimative Ausdruck von Aufmerksamkeit bis ins kleinste Detail. Der Ofen ist mit besonderen handgearbeiteten Keramiken und einem ausziehbaren Warmhaltefach ausgestattet. Ausgestattet mit einem Raumluftventilator, mit der PELLETPOWER® Technologie (nur Idra), dem Wärmetauscher THERMOCORE® und dem einfachen EASY CLEANING Reinigungssystem. Verfügbar in den Versionen Air, Plus und Idra.
- ENG Refined elegance in a romantic style, for all those who love to surround themselves with precious furnishings. Montreux is the ultimate expression of attention to detail from the precious floral frieze worked by hand to the practical hot plate covered by retractable glass and earthenware. Equipped with the motorised fan technology PELLETPOWER® (Idra model) heat exchanger THERMOCORE® and simplified cleaning system EASY CLEANING. Available in versions, Air, Plus and Idra.
- FRA Élégance raffinée en style romantique, pour qui aime s'entourer d'objets précieux. Le Montreux représente la plus grande expression dans le soin du détail, de la précieuse décoration florale faite à la main au tiroir-chauffe-plats pratique, en cristal et céramique. Doté du brûleur motorisé avec technologie PELLETPOWER® (version Idra), de l'échangeur de chaleur THERMOCORE®, et du système de nettoyage ordinaire et extraordinaire simplifié EASY CLEANING. Disponible dans les versions Air, Plus et Idra.
- ESP Elegancia refinada en un estilo romántico, para todos los que aman rodearse con muebles preciosos. Montreux es la máxima expresión de la atención al detalle, desde el precioso friso floral hecho a mano hasta el práctico hueco retráctil para calentar comidas en cristal y cerámica. Equipada con la tecnología de quemador motorizado PELLETPOWER® (versión Idra), intercambiador de calor THERMOCORE® y limpieza ordinaria y extraordinaria simplificadas EASY CLEANING. Disponible en versión Air, Idra y Plus.

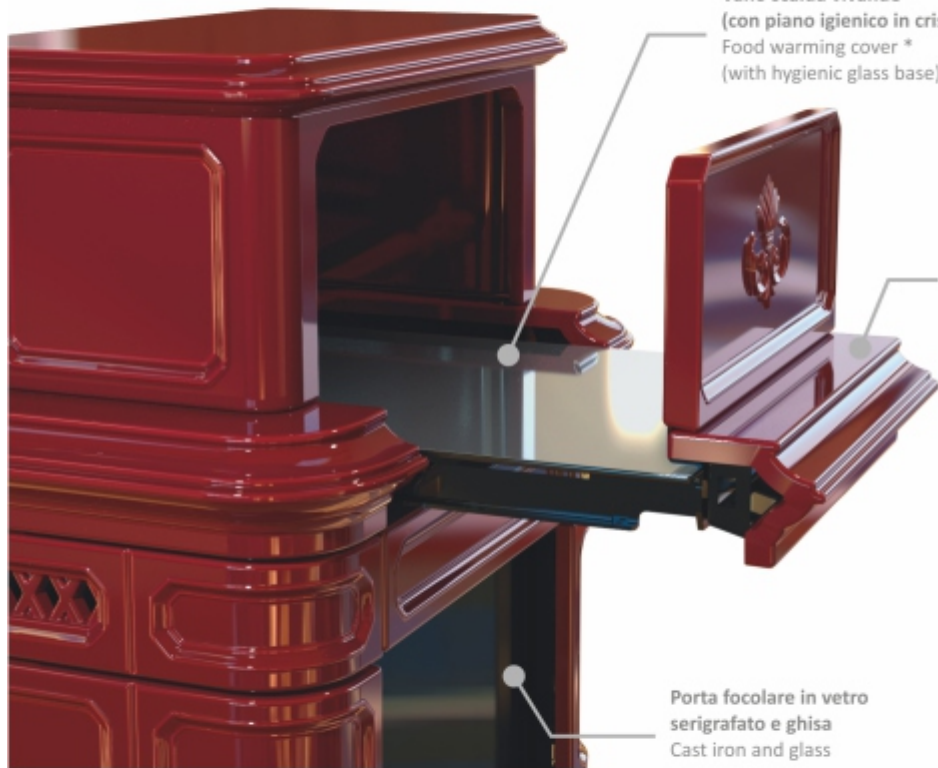

Vano scalda vivande*
(con piano igienico in cristallo)
Food warming cover*
(with hygienic glass base)

Preziosa maiolica artigianale
fatta a mano
Precious handmade majolica
by master craftsmen

Porta focolare in vetro
serigrafato e ghisa
Cast iron and glass
firebox door

bruciatore brevettato
PELLETPOWER[®]
Di serie su termostufe versione «Idra»
Standard on thermo-stoves "Idra" version



• **Thermocomfort* (optional)**
Radiocomando con termostato ambiente;
Funksteuerung mit Raumthermostat;
Radio control with room thermostat;
Radiocommande avec thermostat d'ambiance;
Radio control con termostato de ambiente;



• **INTEGRA TR-PACK** (optional)**
Thermocell[®] (400 o 500 lt)
Thermopuffer (400 o 500 lt)
Thermosole[®] (2.0 e 2.6)



• **External primary air input (optional)**
Input esterno dell'aria primaria;
Eintritt der primäre Luft vom außen;
External primary air input;
Entrée d'air primaire externe;
Entrada externa de aire primario;



													Air
													Plus
													Idra



1356x660x641	
Air 4,8 - 13,2 Plus 4,8 - 13,2 Idra 3,8 - 13,5	
Air 4,3 - 11,4 Plus 4,3 - 11,4 Idra 3,5 - 12,2	
Air 1 - 2,7 Plus 1 - 2,7 Idra 0,8 - 2,9	
Air 19 Plus 15 Idra 19	

* Non disponibile per versione «Idra»
* Not available on "Idra" version
** Solo versione «Idra»
** Only on "Idra" version

La tipologia di fiamma ed il focolare possono variare a seconda delle versioni
Flame and the firebox can vary according to different model

SETTECENTO

- ITA L'esclusiva stufa a pellet dall'inusuale e raffinato design ispirato all'antichità. Rifinita in ogni suo dettaglio grazie alla combinazione dei materiali quali il metallo, la ghisa ed il cristallo curvo. Di serie un pratico e igienico piano scaldavivande di facile pulizia sopra al quale è possibile appoggiare il versatile coperchio scaldavivande Dinner (optional).
- DEU Der einzigartige Pelletofen, der sich durch ein ungewöhnliches und anspruchsvolles Design definiert und welches durch die Antike inspiriert wurde. Jedes Detail wurde aus Materialien wie Metall, Gusseisen und gebogenem Glas neu gefertigt. Serienmäßig ist die praktische und hygienische Speiseaufwärmplatte; darauf kann die vielseitige Speiseaufwärmende Kuppel Dinner gestellt werden (als Zubehör erhältlich).
- ENG The unique pellet stove defined by the unusual and sophisticated design inspired by antiquity. Finished in every detail by the combination of materials such as metal, cast iron and the curved crystal. Incorporates practicality and hygiene, easy to clean hotplate heats food over which you can place the versatile food warmers Dinner (optional).
- FRA Le poêle à granulés exclusif, au design insolite et raffiné, inspiré à l'antiquité, soigné dans tous ses détails, grâce à la combinaison de différents matériaux tels que métal, fonte, et cristal courbé. Doté d'un chauffe-plats vitrifié pratique et hygiénique, simple à nettoyer, qui peut être complété (en option) par le couvercle-chauffe-plats DINNER.
- ESP La estufa de pellets única por su diseño inusual y sofisticado, inspirado en la antigüedad. Acabada en todos sus finos detalles gracias a la combinación de materiales tales como el metal, la fundición y el cristal curvado. Equipado con un práctico plano para calentar comidas hecho en cristal higiénico y fácil de limpiar, al cual se puede añadir la versátil tapa DINNER (opcional).

SCUBA



- ITA Stufa a pellet canalizzabile inseribile all'interno di un caminetto esistente grazie alla ridotta altezza, inferiore a 68 cm. Appoggiata a terra con l'ausilio del piedistallo (optional) diventa un elemento d'arredo. L'accessorio «Living» (optional) permette all'utilizzatore di integrare Scuba con una elegante seduta reversibile dotata di vano porta pellet a scomparsa.
- DEU Kanalisierbare Pelletofen, der dank der geringer Höhe unter 68 cm in einen schon bestehenden Kamin eingebaut werden kann. Der Ofen kann direkt auf den Boden mit einem Standfuss gestellt werden (als Zubehör erhältlich) und wird somit zum wahren Einrichtungsmöbel. Das Zubehör "Living" (Optional) erlaubt dem Benutzer, den Ofen Scuba mit einer eleganten Sitzmöglichkeit zu integrieren: die Bank kann links oder rechts benutzt werden und verfügt über ein unsichtbares Pelletstaufach.
- ENG Pellet stove able to utilise an existing hearth thanks to the reduced height of less than 68 cm. Resting on the ground with the help of the pedestal (optional) it becomes a piece of furniture. The accessory «Living» allows the user to complete Scuba with an elegant bench (optional) reversible with hidden compartment to insert the pellets.
- FRA Poêle à granulés canalisable, qui peut être placé à l'intérieur d'une cheminée existante, grâce à sa hauteur réduite (moins de 68 cm). Posé au sol, sur son pied (option), le Scuba devient un élément de décor. Le meuble « Living » (option), banquette élégante et réversible dotée d'un compartiment fermé pour les sacs de granulés, est l'idéal pour profiter pleinement du Scuba.
- ESP Estufa de pellets canalizable que se puede inserir en una chimenea existente gracias a su reducida altura de menos de 68 cm. Se puede apoyar al suelo con la ayuda del pedestal (opcional) convirtiéndose en un mueble. El accesorio «Living» permite al usuario integrar Scuba con un elegante banco (opcional) provisto de varios compartimentos ocultos.



Uscite canalizzazione disponibili:
due posteriori
Duct vents options: two rear

Schermo comandi programmabile,
con telecomando
Programming control panel,
with remote control

Panca in legno «Living» (optional):
reversibile lato sx - dx, con vano magazzino
sacchi pellet (reversibile sx - dx)
"Living" (optional): reversible wood bench
with pellet hidden compartment
(on right or left side)

Porta focolare
in vetro ceramico
serigrafato e ghisa
Precious cast iron
and glass firebox door



Maniglia removibile.
Essenzialità nel design
e maggior sicurezza
Removable door
handle. Essential
design and high safety



8m^x1
4m^x2



• Thermocomfort (optional)
Radiocomando con termostato ambiente;
Funksteuerung mit Raumthermostat;
Radio control with room thermostat;
Radiocommande avec thermostat d'ambiance;
Radio control con termostato de ambiente;



• Panca «Living» per Scuba (optional)
«Living» bench for Scuba (optional)



• Piedistallo per Scuba (optional)
Pedestal for Scuba (optional)



• Scarico fumo centrale (optional)
Central flue outlet (optional)

Bianco

Grigio

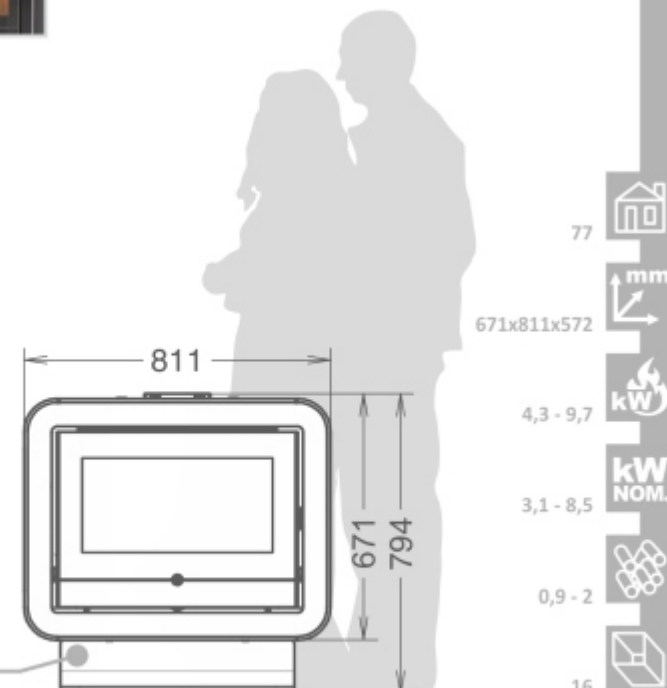

77

mm

671x811x572

4,3 - 9,7 kW

3,1 - 8,5

kW NOM.

0,9 - 2

0,9 - 2

16

16



CUBA 10

- ITA** Cuba, la stufa camino canalizzabile che non necessita di opere murarie o complesse e costose procedure nell'installazione, arricchisce con personalità e carattere l'ambiente in cui si trova. Ideale per chi ama le linee raccordate e moderne, il frontale nero lucido esalta la serigrafia del vetro e la forma del rivestimento.
- DEU** Cuba, der kanalisierbarer Ofen/Kamin, der keine Mauerwerk oder komplexe und teure Verfahren in der Installation braucht, angereichert mit Persönlichkeit und Charakter des Umfeldes, in dem er sich befindet. Ideal für diejenigen, die die modernen und verbunden Linien lieben, der vordere glänzend schwarz erhebt das Siebdruck des Glases und der Form der Beschichtung.
- ENG** Cuba, pellet-powered stove simple and uncomplicated to install and full of charm and personality. For people who love shapely and modern design, its gloss black frame enhances its many other attractive features. Equipped with air ducting system and incorporating the very latest technology, this appliance will make a lovely addition to your home.
- FRA** Cuba, le poêle-cheminée canalisable qui ne nécessite pas d'ouvrages de maçonnerie, ni de procédures d'installation coûteuses et complexes, enrichi avec personnalité et caractère la pièce dans laquelle il se trouve. Idéal pour qui aime les lignes raccordées et modernes, la façade noir brillant exalte la sérigraphie de la vitre et la forme du revêtement.
- ESP** Cuba, la estufa-chimenea con tubos que no necesita de obras de albañilería y tampoco de caras y complicadas instalaciones, enriquece con personalidad y carácter el espacio a su alrededor. Ideal para los que quieren líneas suaves y modernas, con su frontal negro brillante que destaca la serigrafía del cristal y la forma del acabado.

Uscite canalizzazione disponibili:
due posteriori
Duct vents options: two rear

Schermo comandi programmabile,
con telecomando
Programming control panel,
with remote control

Accesso facilitato al caricamento
del pellet con sistema push and pull
Simplified access to the pellet tank
by means of the push and pull system

Porta focolare
in vetro ceramico
serigrafato e ghisa
Precious cast iron
and glass firebox door

Maniglia removibile. Essenzialità
nel design e maggior sicurezza
Removable door handle. Essential
design and high safety

Frontale con preziosa
finitura lucida. Esalta la
serigrafia del vetro focolare
Precious cast iron
and glass firebox door

Vano porta oggetti
Glove compartment



8m^x1
4m^x2



• **Thermocomfort (optional)**
Radiocomando con termostato ambiente;
Funksteuerung mit Raumthermostat;
Radio control with room thermostat;
Radiocommande avec thermostat d'ambiance;
Radio control con termostato de ambiente;



• **Scarico fumo centrale (optional)**
Central flue outlet (optional)

Bianco

Grigio

Nero

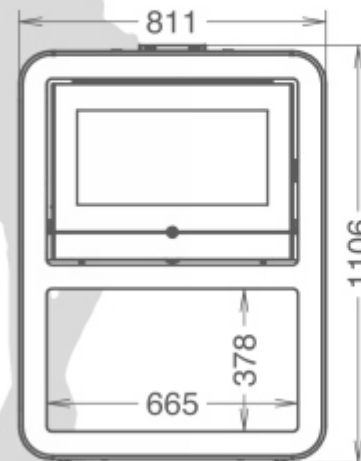
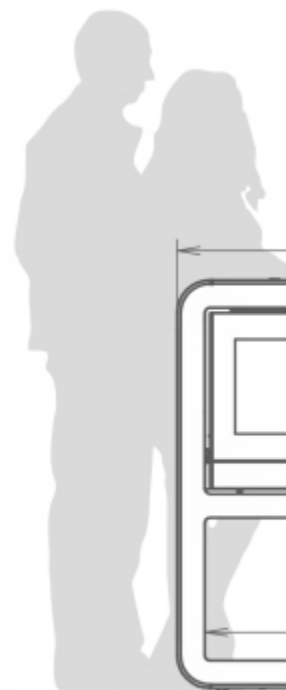

1106x811x572

77

mm

3,4 - 9,5



kW
NOM.

0,8 - 1,9



15





CUBA 12

ITA Una nuova classe di prodotti, dedicata a coloro che amano il camino e pretendono la comodità della stufa a pellet. La collezione Cuba offre un forte contenuto tecnologico, prodotti canalizzabili, contemporanei in grado di soddisfare il benessere della propria famiglia, un nuovo modo di riscaldare.

DEU Eine neue Klasse von Produkten, gewidmet diejenigen, die den Kamin lieben und behaupten den Komfort der Pelletofen. Die Cuba Kollektion bietet einen starken Inhalt High-Tech, Produkte mit der Möglichkeit zur Kanalisierung der Luft, zeitgenössische und in der Lage, um das Wohlergehen seiner Familie zu treffen, eine neue Art zu heizen.

ENG A new range of products designed for fireplace lovers with the additional convenience of a pellet powered appliance. Equipped with air ducting system and incorporating the very latest technology, this appliance will make a lovely addition to your home.

FRA Une nouvelle classe de produits, dédiée aux personnes qui aiment la cheminée et prétendent la commodité du poêle à granulés. La collection Cuba offre un important contenu technologique. Produits canalissables, contemporains, capables de satisfaire le bien-être de toute la famille, une nouvelle façon de chauffer.

ESP Una nueva gama de productos, dedicada a los que quieren la chimenea y también la comodidad de la estufa de pellet. La gama Cuba ofrece un fuerte contenido tecnológico. Productos canalizables, modernos, en grado de satisfacer el bienestar de cada familia, un nuevo modo de calentar.

Uscite canalizzazione disponibili:
due posteriori
Duct vents options: two rear

Schermo comandi programmabile,
con telecomando
Programming control panel,
with remote control

Accesso facilitato al caricamento
del pellet con sistema push and pull
Simplified access to the pellet tank
by means of the push and pull system

Multyway Air System:
flusso aria orientabile
(fronte - retro - destro - sinistro)
Multyway Air System: adjustable air flow
(front -rear-right-left)

Maniglia removibile. Essenzialità
nel design e maggior sicurezza
Removable door handle. Essential
design and high safety

Porta focolare
in vetro ceramico
serigrafato e ghisa
Precious cast iron
and glass firebox door

Vano porta oggetti
Glove compartment



• Thermocomfort (optional)
Radiocomando con termostato ambiente;
Funksteuerung mit Raumthermostat;
Radio control with room thermostat;
Radiocommande avec thermostat d'ambiance;
Radio control con termostato de ambiente;



• Scarico fumo centrale (optional)
Central flue outlet (optional)

Bianco

Grigio

Nero



12m^x1
6m^x2

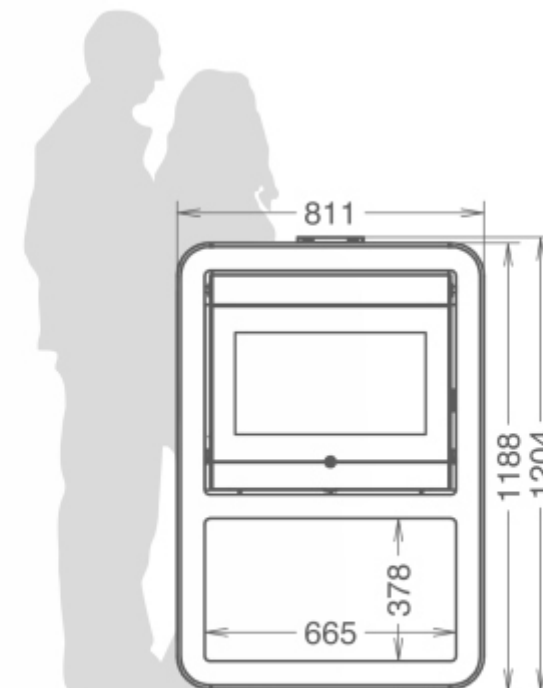

1188x811x568

96

mm

4,8 - 12



4,4 - 10,7



0,8 - 2,4



23





INSERT 49

- | | |
|-----|--|
| ITA | E' il più compatto della sua categoria grazie ai soli 490 mm di altezza e 500 mm di profondità, riesce a riscaldare più ambienti attraverso la canalizzazione dell'aria. E' dotato di vetro focolare curvo per una più ampia visione del fuoco. |
| DEU | Das kompakteste Modell seiner Klasse mit ganzen 490 mm Höhe und 500 mm Tiefe kann zur Beheizung von mehreren Räumen auch an Warmluftkanäle angeschlossen werden. Ausgestattet mit dem gekrümmt Glas des Feuerraum für eine die globale Vision der Feuer. |
| ENG | With its 490 mm height and 500 mm depth it is the most compact appliance in its category, yet, by simply ducting the hot air it produces, it manages to heat several room. Equipped with a curved firebox glass for a wider view of the fire. |
| FRA | Le plus compact de sa catégorie de par sa hauteur de 490 mm et sa profondeur de 500 mm, en mesure de chauffer plusieurs pièces à travers la canalisation de l'air. Doté de vitre de foyer arrondie pour une vision du feu plus ample. |
| ESP | El más compacto de su categoría, mide sólo 490 mm de altura y 500 mm de profundidad, que calienta varios locales mediante la canalización del aire. Equipado con cristal curvado para una visión más ancha del hogar. |

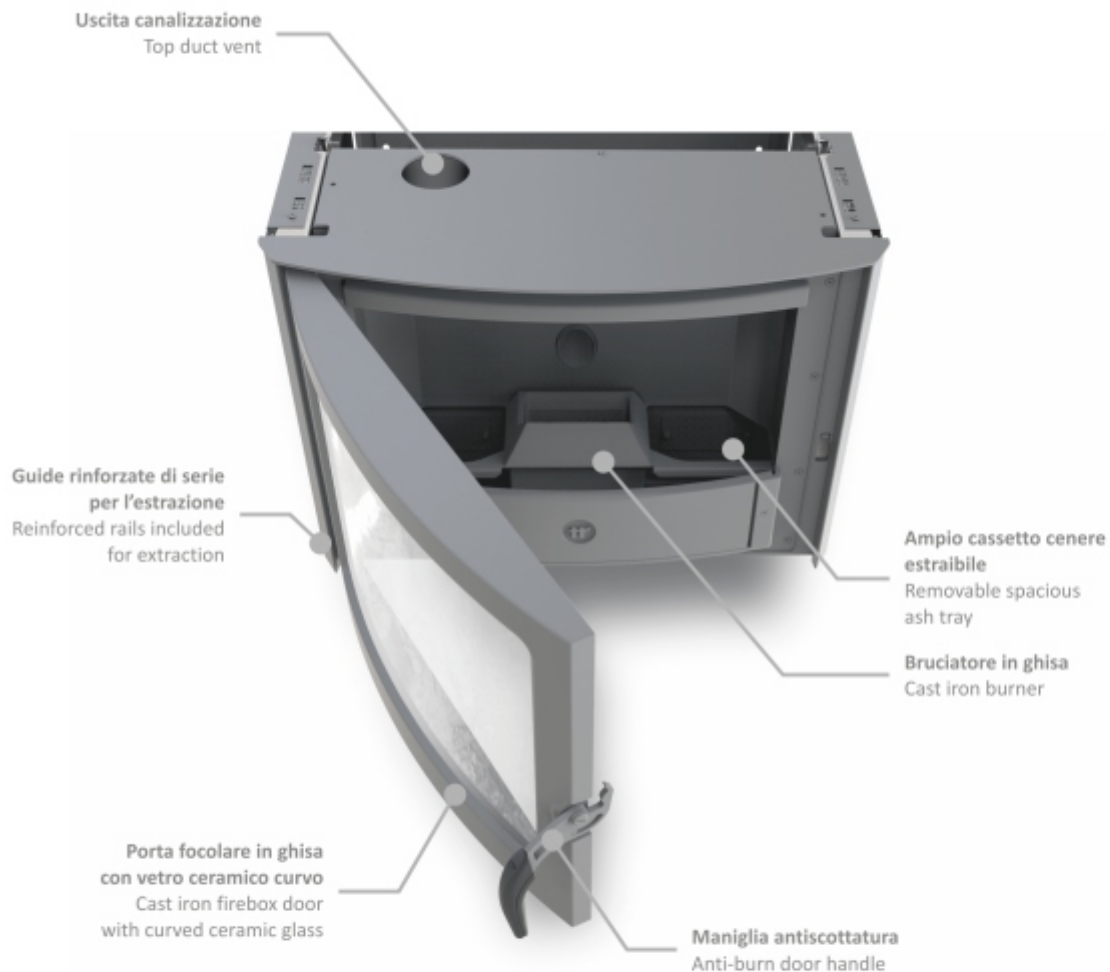

PATENTED SYSTEM

• Kit rapido mobile rigido per Insert 49 - 60 (optional)

Sistema di estrazione del pellet anche durante il funzionamento

Fast rigid mobile kit for Insert 49 - 60 (optional)
Extracting insert system for pellet refueling even during the working phase.



• Kit Supporto con piedistallo e scivolo per installazione fissa (optional)

Support kit with pedestal and chute for fixed installation (optional)



• Kit Supporto canalizzazione per installazione fissa (optional)
Duct vent support kit for fixed installation (optional)



Radiocomando con termostato ambiente
Radio control with room temperature thermostat

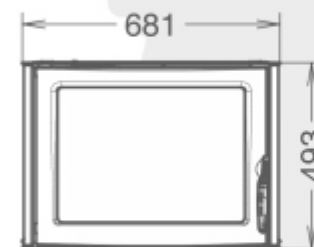

Dimensioni parte incassata
H x L x P (mm) 493x681x500
Recessed part dimensions
H x W x D (mm) 493x681x500

77



mm



493x681x622



3,4 - 9,5



3,1 - 8,5



0,8 - 1,9



12



INSERT 60

- ITA È la risposta per chi vuole recuperare i caminetti esistenti e inutilizzati, per chi non può rinunciare al fascino del camino ma pretende la comodità della stufa a pellet. È dotato di vetro focolare curvo per una più ampia visione del fuoco.
- DEU Ist die richtige Lösung für diejenigen, die vorhandene, aber ungenutzte Kamine wieder ihrem Zweck zuführen möchten, die den Zauber eines Kamins nicht missen wollen, aber die Bequemlichkeit des Pelletofens erwarten. Ausgestattet mit dem gekrümmt Glas des Feuerraum für eine für eine globale Vision der Feuer.
- ENG Is the ideal solution for those who wish to make use of an existing, unused fireplace, for those who can't resist the charm of a fireplace but want the convenience of a pellet heater. Equipped with a curved firebox glass for a wider view of the fire.
- FRA Est la solution idéale pour ceux qui souhaitent récupérer une cheminée existante et inutilisée, pour ceux qui ne peuvent renoncer au charme de la cheminée mais qui prétendent la praticité d'un poêle à granulés. Doté de vitre de foyer arrondie pour une vision du feu plus ample.
- ESP Es la solución para quien desea recuperar el hogar existente inutilizado o para quien no quiere renunciar al encanto del hogar pero pretende la comodidad de la estufa de pellet. Equipado con cristal curvado para una visión más ancha del hogar.

Accesso facilitato al caricamento del pellet, anche durante il funzionamento (con kit rapido mobile rigido)
Easy access to the pellet tank, even during the working phase (fast rigid mobile kit)



Maniglia antiscottatura
Anti-burn door handle

Ampio cassetto cenere estraibile
Removable spacious ash tray

Guide rinforzate di serie per l'estrazione
Reinforced rails included for extraction

Porta focolare in ghisa con vetro ceramico curvo
Cast iron firebox door with curved ceramic glass



PATENTED SYSTEM

• Kit rapido mobile rigido per Insert 49 - 60 (optional)

Sistema di estrazione inserito per la fase di caricamento del pellet anche durante il funzionamento

Fast rigid mobile kit for Insert 49 - 60 (optional)
Extracting insert system for pellet refueling even during the working phase.



• Kit Supporto con piedistallo e scivolo per installazione fissa (optional)
Support kit with pedestal and chute for fixed installation (optional)



Radiocomando con termostato ambiente
Radio control with room temperature thermostat

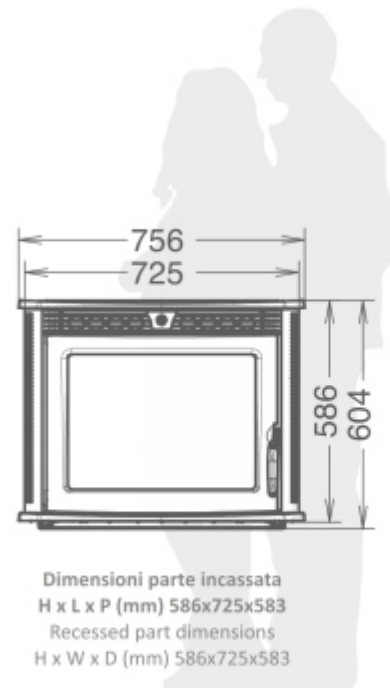

Dimensioni parte incassata
H x L x P (mm) 586x725x583
Recessed part dimensions
H x W x D (mm) 586x725x583

96

mm

604x756x729

4,8 - 12

4,4 - 10,7

0,8 - 2,4

19



INSERT LINE 490

- ITA Caminetto a pellet canalizzabile dal design moderno ed elegante. Grande efficienza e risparmio energetico grazie allo scambiatore a tubi verticale THERMOCORE®, camera di combustione, porta focolare e braciere in ghisa pesante. Pulizia straordinaria e ordinaria semplificata con tecnologia EASY CLEANING, di serie cassetto cenere estraibile. Facile e veloce da installare grazie ai diversi kit di collegamento.
- DEU Kanalisierte Pelletheizeinsatz mit einem modernen und eleganten Design. Mehr Effizienz und Energieeinsparung dank dem Wärmetauscher in vertikalen Röhren THERMOCORE®, Brennkammer, Tür des Feuerraum und Brenntopf in Gusseisen. Ordentliche und außerordentliche Reinigung leichter mit EASY CLEANING System, herausnehmbaren Swirlaschekasten. Einfach und schnell zu installieren, dank dem Anschluss-Set.
- ENG Insert line 490 is an elegant and modern, pellet powered, ducted air fireplace. The innovative design of the vertical tube heat exchanger THERMOCORE® allows the appliance to achieve both a very high performance and maximum energy saving. The front door and the pellet burning pot, constructed in heavy cast iron, add an extra degree of reliability and longevity. Equipped with simplified cleaning system EASY CLEANING and with removable ash pan as standard. Easy and quick to install thanks to support kits.
- FRA Cheminée à granulés canalisable au design moderne et élégant. Grand rendement et économie d'énergie grâce à l'échangeur à tubes vertical THERMOCORE® et à la chambre de combustion, la porte du foyer et le braséro en fonte épaisse. Doté du système de nettoyage ordinaire et extraordinaire simplifié EASY CLEANING, avec tiroir des cendres extractible de série. Simple et rapide d'installation grâce au kit de connexion.
- ESP Insertable de pellet canalizable de diseño moderno y elegante. Gran eficiencia y ahorro energético gracias al intercambiador a tubos verticales THERMOCORE®, Cámara de combustión, puerta y quemador en fundición de alta calidad. Limpiezas ordinarias y extraordinarias simplificadas EASY CLEANING, de serie cajón de cenizas extraíble. Instalación sencilla y rápida gracias a los kits de conexión.

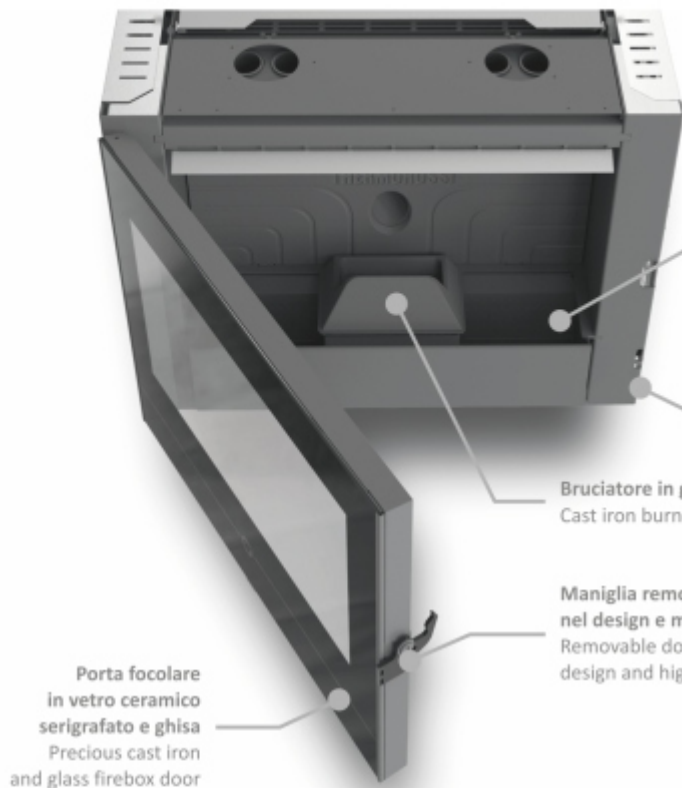

Uscite per canalizzazione disponibili:
due superiori
Duct vents options: two top

Ampio cassetto cenere estraibile
Removable spacious ash tray

Guide rinforzate di serie per l'estrazione
Reinforced rails included for extraction

Brucciatore in ghisa
Cast iron burner

Maniglia removibile. Essenzialità nel design e maggior sicurezza
Removable door handle. Essential design and high safety

Porta focolare in vetro ceramico serigrafato e ghisa
Precious cast iron and glass firebox door



PATENTED SYSTEM

• Kit rapido mobile rigido per Insert Line 490 - 600 (optional)

Sistema di estrazione inserito per la fase di caricamento del pellet anche durante il funzionamento

Fast rigid mobile kit for Insert Line 490 - 600 (optional)
Extracting insert system for pellet refueling even during the working phase



• Kit rapido fisso (optional)
Fast fixed kit (optional)



• Kit Supporto con piedistallo e scivolo per installazione fissa (optional)
Support kit with pedestal and chute for fixed installation (optional)



• Thermocomfort (optional)
Radiocomando con termostato ambiente;
Funksteuerung mit Raumthermostat;
Radio control with room thermostat; Radiocommande avec thermostat d'ambiance;
Radio control con termostato de ambiente;

- CRISTALLO - GLASS
- Bianco
- Bordeaux
- Nero
- CERAMICA - CERAMIC
- Madreperla
- Ollare
- Bronze



Optional: Cornice cristallo o ceramica per Insert Line (disponibile con cristallo bianco, bordeaux, nero, oppure in ceramica bronzo, ollare, madreperla)
Option: Insert Line glass or ceramic framework (available in white, bordeaux and black glass or in bronze, soapstone and pearl ceramic)



Optional: Cornice inox per Insert Line
Option: stainless steel frame for Insert Line

Optional: Cornici per Insert Idra Maxi
Option: Insert Idra Maxi frameworks

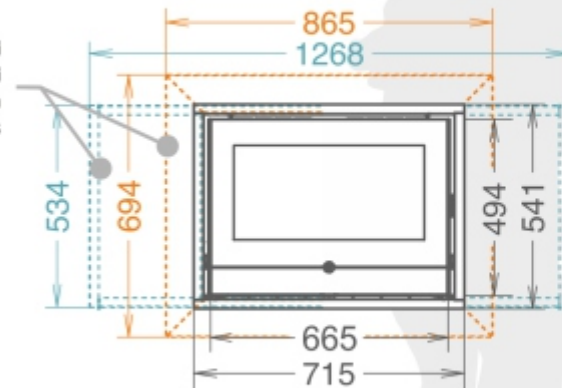

Dimensioni parte incassata: H x L x P (mm) 494x665x644
Recessed part dimensions: H x W x D (mm) 494x665x644



10m^x1
5m^x2

Nero

77

mm

541x715x653

3,4 - 9,5

3,1 - 8,5

0,8 - 1,9

12



INSERT LINE 600

- ITA** Caminetto a pellet canalizzabile dal design moderno ed elegante. Grande efficienza e risparmio energetico grazie allo scambiatore a tubi verticale THERMOCORE®, camera di combustione, porta focolare e braciere in ghisa pesante. Pulizia straordinaria e ordinaria semplificata con tecnologia EASY CLEANING, di serie cassetto cenere estraibile. Facile e veloce da installare grazie al kit di collegamento.
- DEU** Kanalisierte Pelletheizeinsatz mit einem modernen und eleganten Design. Mehr Effizienz und Energieeinsparung dank dem Wärmetauscher in vertikalen Rohren THERMOCORE®. Brennkammer, Tür des Feuerraum und Brenntopf in Gusseisen. Ordentliche und außerordentliche Reinigung leichter mit EASY CLEANING System, herausnehmbaren Swerienaschekasten. Einfach und schnell zu installieren, dank dem Anschluss-Set.
- ENG** Insert line 600 is an elegant and modern, pellet powered, with air ducting fireplace. The innovative design of the vertical tube heat exchanger THERMOCORE® allows the appliance to achieve both a very high performance and maximum energy saving. The front door and the pellet burning pot, constructed in heavy cast iron, add an extra degree of reliability and longevity. Equipped with simplified cleaning system EASY CLEANING and with removable ash pan as standard. Easy and quick to install thanks to the support kit.
- FRA** Cheminée à granulés canalisable au design moderne et élégant. Grand rendement et économie d'énergie grâce à l'échangeur à tubes vertical THERMOCORE® et à la chambre de combustion, la porte du foyer et le braséro en fonte épaisse. Doté du système de nettoyage ordinaire et extraordinaire simplifié EASY CLEANING, avec tiroir des cendres extractible de série. Simple et rapide d'installation grâce au kit de connexion.
- ESP** Insertable de pellet canalizable de diseño moderno y elegante. Gran eficiencia y ahorro energético gracias al intercambiador a tubos verticales THERMOCORE®, Cámara de combustión, puerta y quemador en fundición de alta calidad. Limpiezas ordinarias y extraordinarias simplificadas EASY CLEANING, de serie cajón de cenizas extraíble. Instalación sencilla y rápida gracias a los kits de conexión.

PATENTED SYSTEM - SISTEMA BREVETTATO

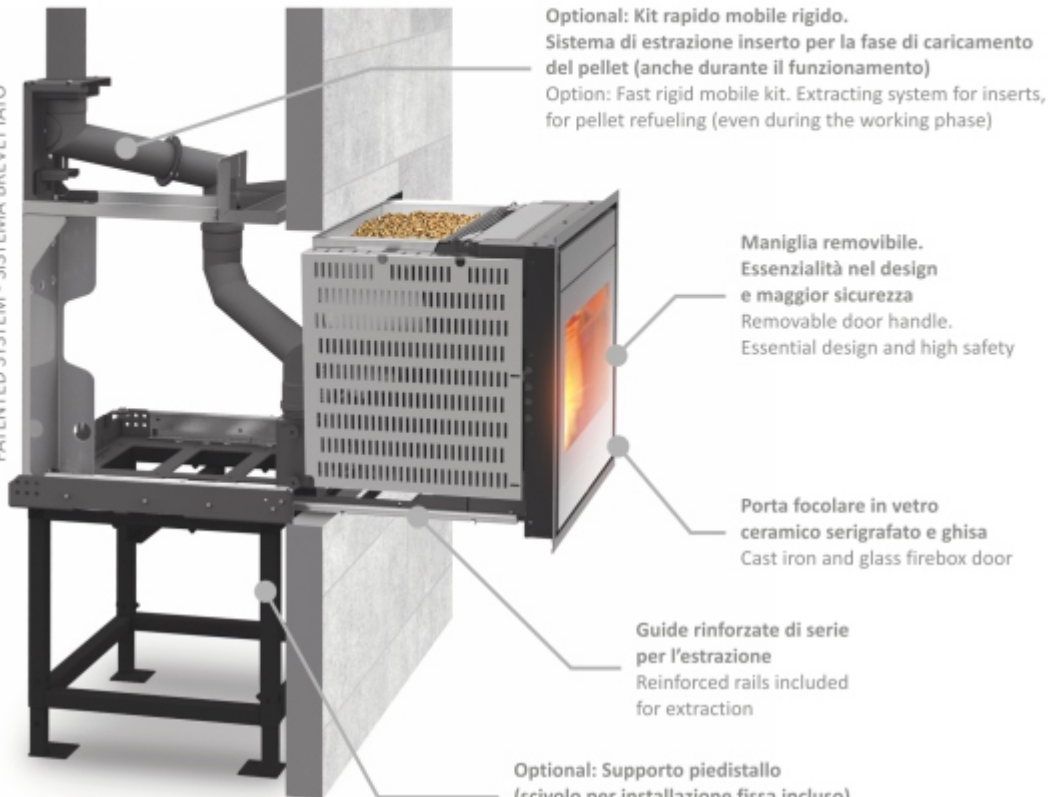

Optional: Kit rapido mobile rigido.
Sistema di estrazione inserito per la fase di caricamento del pellet (anche durante il funzionamento)
Option: Fast rigid mobile kit. Extracting system for inserts, for pellet refueling (even during the working phase)

Maniglia removibile.
Essenzialità nel design e maggior sicurezza
Removable door handle.
Essential design and high safety

Porta focolare in vetro ceramico serigrafato e ghisa
Cast iron and glass firebox door

Guide rinforzate di serie per l'estrazione
Reinforced rails included for extraction

Optional: Supporto piedistallo (scivolo per installazione fissa incluso)
Option: support kit (chute for fixed installation included)

Uscite canalizzazione disponibili: due superiori
Duct vents options: two top

- CRISTALLO - GLASS
- Bianco
- Bordeaux
- Nero
- CERAMICA - CERAMIC
- Madreperla
- Ollare
- Bronze



Optional: Cornice cristallo o ceramica per Insert Line (disponibile con cristallo bianco, bordeaux, nero, oppure in ceramica bronze, ollare, madreperla)
Option: Insert Line glass or ceramic framework (available in white, bordeaux and black glass or in bronze, soapstone and pearl ceramic)



Optional: Cornice inox per Insert Line
Option: stainless steel frame for Insert Line

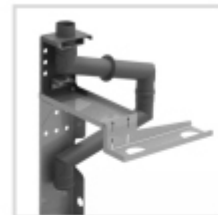

PATENTED SYSTEM

• **Kit rapido mobile rigido per Insert Line 490 - 600 (optional)**

Sistema di estrazione inserito per la fase di caricamento del pellet anche durante il funzionamento

Fast rigid mobile kit for Insert Line 490 - 600 (optional)
Extracting insert system for pellet refueling even during the working phase



• **Kit rapido fisso (optional)**
Fast fixed kit (optional)



• **Kit Supporto con piedistallo e scivolo per installazione fissa (optional)**
Support kit with pedestal and chute for fixed installation (optional)



• **Thermocomfort (optional)**
Radiocomando con termostato ambiente;
Funksteuerung mit Raumthermostat;
Radio control with room thermostat; Radiocommande avec thermostat d'ambiance;
Radio control con termostato de ambiente;

Optional: Cornici per Insert Idra Maxi
Option: Insert Idra Maxi frameworks

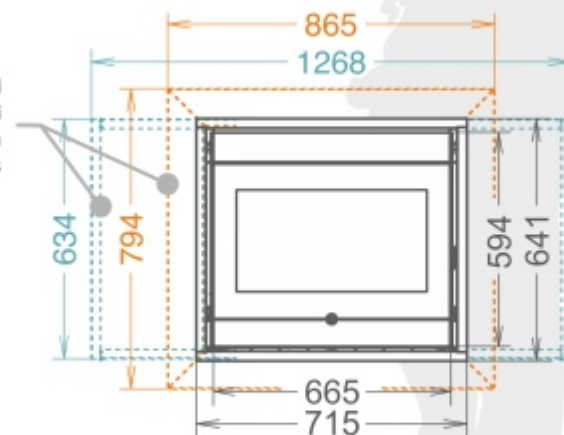

Dimensioni parte incassata: H x L x P (mm) 594x665x644
Recessed part dimensions: H x W x D (mm) 594x665x644



16m^x1
8m^x2

Nero



96



mm

641x715x655



4,8 - 12



4,4 - 10,7



0,8 - 2,4



20

INSERT LINE idra

- ITA** Caminetto a pellet dal design moderno ed elegante. Grande efficienza e risparmio energetico grazie allo scambiatore a tubi verticale THERMOCORE®, camera di combustione, porta focolare e braciere in ghisa pesante. Dotato di bruciatore motorizzato con tecnologia PELLETPOWER®. Pulizia straordinaria e ordinaria semplificata con tecnologia EASY CLEANING, di serie cassetto cenere estraibile. Facile e veloce da installare grazie al kit di collegamento.
- DEU** Pelletheizeinsatz mit einem modernen und eleganten Design. Mehr Effizienz und Energieeinsparung dank den Wärmetauscher in vertikalen Rohren THERMOCORE®, Brennkammer, Tür des Feuerraum und Brenntopf in Gusseisen. Ausgestattet mit dem PELLETPOWER® Patentierter Brenner. Ordentliche und außerordentliche Reinigung leichter mit EASY CLEANING System, herausnehmbaren Swerienaschekasten. Einfach und schnell zu installieren, dank dem Anschluss-Set.
- ENG** Insert line 600 Idra is an elegant and modern pellet powered fireplace. The innovative design of the vertical tube heat exchanger THERMOCORE® allows the appliance to achieve both a very high performance and maximum energy saving. The front door and the pellet burning pot, constructed in heavy cast iron, add an extra degree of reliability and longevity. Equipped with the PELLETPOWER® technology patented burner, with simplified cleaning system EASY CLEANING and with removable ash pan as standard. Easy and quick to install thanks to the support kit.
- FRA** Cheminée à granulés au design moderne et élégant. Grand rendement et économie d'énergie grâce à l'échangeur à tubes vertical THERMOCORE® et à la chambre de combustion, la porte du foyer et le brasero en fonte épaisse. Doté du brûleur motorisé avec technologie PELLETPOWER®. Doté du système de nettoyage ordinaire et extraordinaire simplifié EASY CLEANING, avec tiroir des cendres extractible de série. Simple et rapide d'installation grâce au kit de connexion.
- ESP** Insertable de pellet de diseño moderno y elegante. Gran eficiencia y ahorro energético gracias al intercambiador a tubos verticales THERMOCORE®. Cámara de combustión, puerta y quemador en fundición de alta calidad. Equipada con la tecnología de quemador motorizado PELLETPOWER®. Limpiezas ordinarias y extraordinarias simplificadas EASY CLEANING, de serie cajón de cenizas extraíble. Instalación sencilla y rápida gracias a los kits de conexión.

PATENTED SYSTEM - SISTEMA BREVETTATO

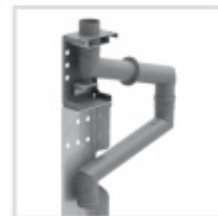
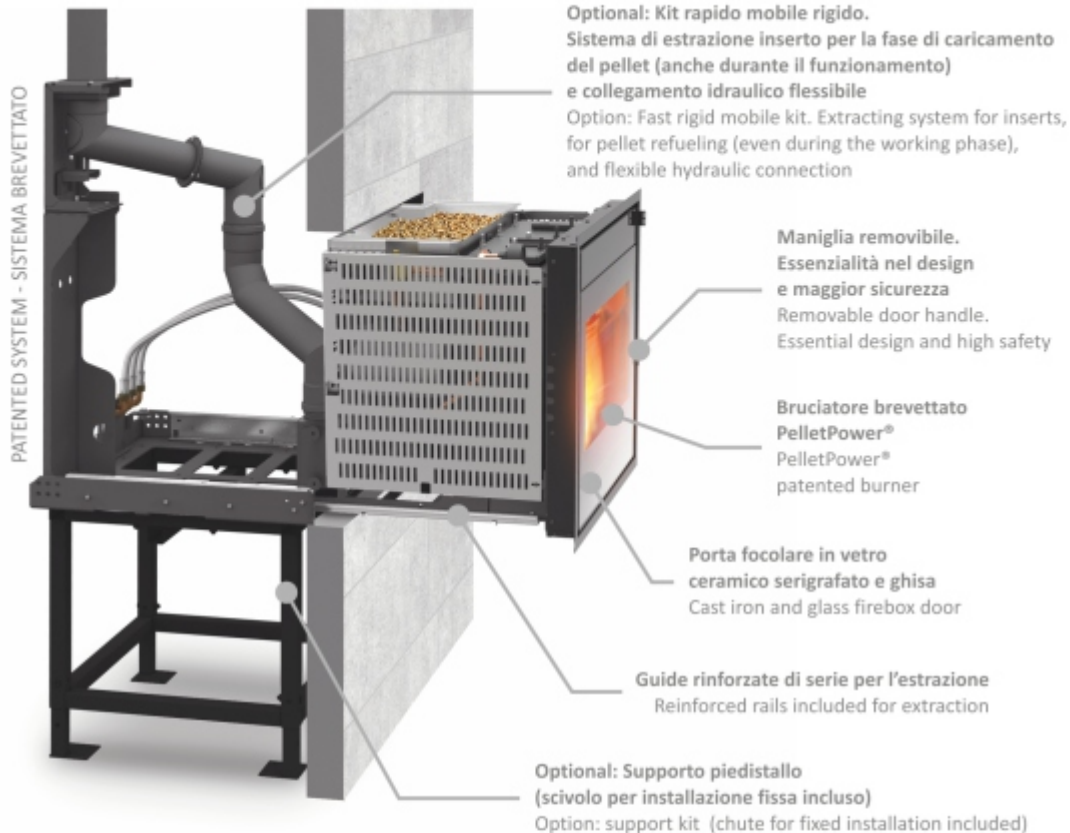

PATENTED SYSTEM

• Kit rapido mobile rigido per Insert Line Idra (optional)

Sistema di estrazione inserito per la fase di caricamento del pellet anche durante il funzionamento

Fast rigid mobile kit for Insert Line Idra (optional)
Extracting insert system for pellet refueling even during the working phase



• Kit rapido fisso (optional)
Fast fixed kit (optional)



• Kit Supporto con piedistallo e scivolo per installazione fissa (optional)
Support kit with pedestal and chute for fixed installation (optional)



• INTEGRA TR-PACK**** (optional)
Thermocell® (250/400/500 lt);
Thermopuffer (400/500 lt);
Thermosole® (2.0 e 2.6);



Optional: Cornice cristallo o ceramica per Insert Line Idra (disponibile con cristallo bianco, bordeaux, nero, oppure in ceramica bronzo, ollare, madreperla)
Option: Insert Line Idra glass or ceramic framework (available in white, bordeaux and black glass or in bronze, soapstone and pearl ceramic)



Optional: Cornice inox per Insert Line Idra
Option: stainless steel frame for Insert Line Idra

Optional: Cornici per Insert Idra Maxi
Option: Insert Idra Maxi frameworks

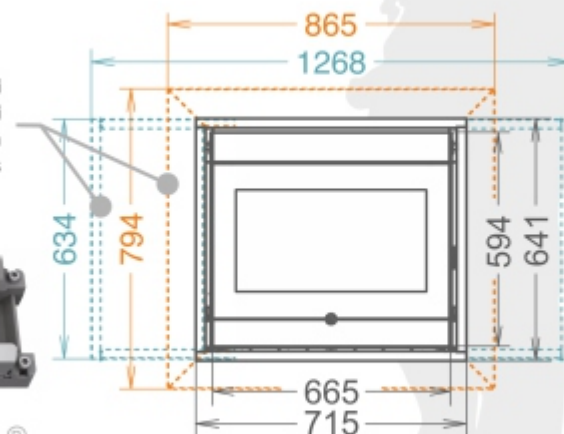

Dimensioni parte incassata: H x L x P (mm) 594x665x644
Recessed part dimensions: H x W x D (mm) 594x665x644

Nero



128



641x715x655



5,5 - 15,7



5 - 14,2



4,4 - 11,8



1,1 - 3,3



20



INSERT Idra Maxi

- ITA La gamma dei termocamini a pellet si arricchisce con un nuovo modello ancora più potente. Dal design moderno ed elegante offre una grande efficienza e risparmio energetico grazie allo scambiatore a tubi verticale THERMOCORE®. Porta focolare e braciare in ghisa pesante. Dotato di bruciatore motorizzato con tecnologia PELLETPOWER® garantisce una pulizia straordinaria e ordinaria semplificata, di serie un grande cassetto cenere estraibile. Facilità e rapidità di installazione sono le sue doti esclusive.
- DEU Die wassergeführte Einsatz-Familie erweitert sich mit einem neuen noch leistungsfähigeren Modell. Der Insert Idra Maxi verbindet elegantes und modernes Design mit hoher Effizienz und großer Energieeinsparung dank des vertikalen Rohrwärmetauschers THERMOCORE®. Durch die Ausstattung mit dem innovativen und patentierten PELLETPOWER® Reinigungssystem, der großzügig dimensionierten und herausnehmbaren Aschenlade wird eine einfache Reinigung garantiert. Simple und schnelle Installation ist sein Alleinstellungsmerkmal.
- ENG The idra pellet-burning inserts collection enhances itself with a new model, even more powerful. From the elegant and the modern design, it offers high thermal efficiency and energy saving, thanks to the vertical pipes heat exchanger THERMOCORE®, heavy cast iron burning grate and firebox door. Equipped with the PELLETPOWER® innovative patented burner, it assures easier cleaning operations, equipped with a removable wide ash pan as standard. An easy and rapid installation is its distinguishing feature.
- FRA La gamme des thermo-cheminées à granulés s'enrichit d'un nouveau modèle encore plus puissant. D'un design moderne et élégant, il offre une efficacité et une économie d'énergie élevées grâce à son échangeur tubulaire vertical THERMOCORE®. Porte de foyer et brûleur en fonte épaisse. Doté du brûleur motorisé avec technologie brevetée PELLETPOWER®, il garantit des nettoyages ordinaires et extraordinaires simplifiés. De série un grand tiroir des cendres extractible. Facilité et rapidité d'installation sont des dotes exclusives.
- ESP La gama de chimeneas de pellets se enriquece con un nuevo modelo más potente. Con su diseño moderno y elegante, ofrece una alta eficiencia y ahorro energético gracias al intercambiador de tuberías verticales THERMOCORE®. Puerta del hogar y quemador en hierro fundido pesado. Equipado con quemador motorizado con tecnología PELLETPOWER®, que garantiza una limpieza y un mantenimiento simplificados. De serie también un cenicero extraíble de gran tamaño. Facilidad y rapidez de instalación son sus características exclusivas.

Schermo comandi programmabile
Programming control panel

Botola per il caricamento pellet e pannello comandi a scomparsa
Fuel loading hatch with retractable control panel

Scambiatore di calore con tecnologia Thermocore
Thermocore pipe heat exchanger

Porta focolare in vetro ceramico serigrafato e ghisa
Cast iron and glass inlaid firebox door

Maniglia removibile.
Essenzialità nel design e maggior sicurezza
Removable door handle.
Essential design and added safety

Brucciore brevettato PelletPower®
PelletPower® patented burner

Monoblocco focolare estraibile con ruote.
Facilità nelle operazione di installazione e manutenzione.
Monoblocco focolare estraibile con ruote.
Facilità nelle operazione di installazione e manutenzione.

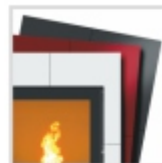

Optional: Cornice cristallo Insert Line Idra Maxi (disponibile con cristallo bianco, bordeaux o nero)
Option: Insert Line Idra Maxi glass framework (available in white, bordeaux or black)

Nero



• INTEGRA TR-PACK (optional)
Thermocell® (250/400/500 lt);
Thermopuffer (400/500 lt);
Thermosole® (2.0 e 2.6);



• Valvola termostatica a 3 vie
1" FFF 55 OT (optional);
Thermostatic valve 3 ways
1" FFF 55 OT (optional);
Vanne thermostatique 3 voies
1" FFF 55 OT (optional);



• Sonda PT100 (optional - min 2 pz) per funzione «THERMOCONTROL»;
PT100 sensor (optional - min 2 pc) for «THERMOCONTROL» function;
Sonde PT100 (optional - min 2 pcs) pour fonction «THERMOCONTROL»;

Optional: Cornice cristallo per Insert Idra Maxi
Option: Insert Idra Maxi glass framework

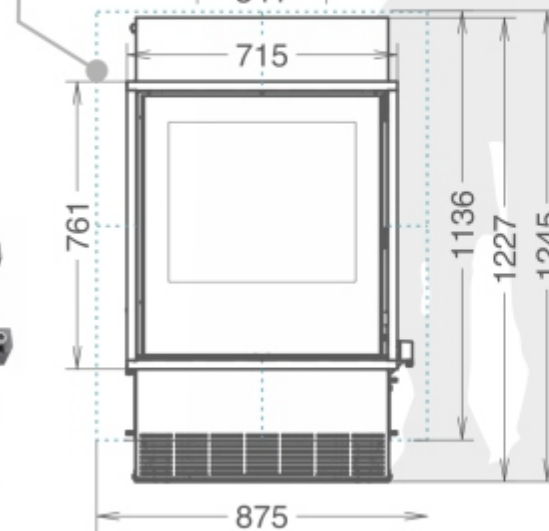
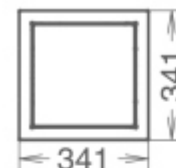

761x755x625

222



6,6 - 26,4



6,2 - 24,7



4,6 - 20,3



1,37 - 5,48



37





6000 maiolica

ITA Linee delicate ed armoniose si sposano con forme arrotondate, arricchite da preziose maioliche fatte a mano o rivestimenti in acciaio inox o verniciato. Grande efficienza e risparmio energetico grazie allo scambiatore a tubi verticale THERMOCORE®, camera di combustione, porta focolare e braciere in ghisa pesante. E' dotata di vetro focolare curvo per una più ampia visione del fuoco.

DEU Feingezogene und harmonische Linien vereinigen sich mit abgerundeten Formen, die noch durch wertvolle handgefertigte Majolikkacheln oder Verkleidungen in Edelstahl oder lackiertem Stahlblech bereichert werden. Mehr Effizienz und Energieeinsparung dank den Wärmetauscher in vertikalen Rohren THERMOCORE®, Brennkammer, Tür des Feuerraum und Brenntopf in Gusseisen. Ausgestattet mit dem gekrümmt Glas des Feuerraum für eine breitere Sicht auf das Feuer.

ENG Delicate flowing lines are united with rounded forms and decorated with beautiful hand-made majolica ceramic tiles or stainless/painted steel coverings. The innovative design of the vertical tube heat exchanger THERMOCORE® allows the appliance to achieve both a very high performance and maximum energy saving. The front door and the pellet burning pot, constructed in heavy cast iron, add an extra degree of reliability and longevity. Equipped with a curved firebox glass for a wider view of the fire.

FRA Les lignes délicates et harmonieuses se marient avec les formes arrondies, enrichies de faïences précieuses faites à la main ou d'habillages en acier inox/vernis. Grand rendement et économie d'énergie grâce à l'échangeur à tubes vertical THERMOCORE® et à la chambre de combustion, la porte du foyer et le braséro en fonte épaisse. Doté de vitre de foyer arrondie pour une vision du feu plus ample.

ESP Líneas delicadas y armoniosas se combinan con formas redondeadas, enriquecidas con baldosas de cerámica de gran valor, hechas a mano o con revestimientos laterales de acero inox o pintado. Gran eficiencia y ahorro energético gracias al intercambiador a tubos verticales THERMOCORE®. Cámara de combustión, puerta y quemador en fundición de alta calidad. Equipada con cristal curvado para una visión más ancha del hogar.



• **Thermocomfort (optional)**
Radiocomando con termostato ambiente;
Funksteuerung mit Raumthermostat;
Radio control with room thermostat;
Radiocommande avec thermostat d'ambiance;
Radio control con termostato de ambiente;

Maiolica	
Bianco	
Beige	
Bordeaux	
Nero	
Metalcolor	
Beige	
Bordeaux	
Grigio	
Maiolica nera e Inox	
Nero	

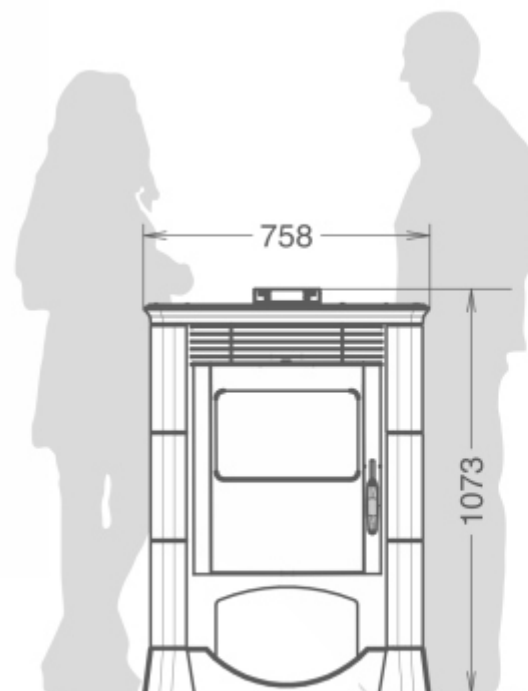

97	
1073x757x633	
5,6 - 12,4	
4,8 - 10,8	
1,2 - 2,6	
23	





DORICA supreme metalcolor

- ITA Dorica Supreme, colonna di fuoco dalla linea sobria e scolpita grazie all'alternanza dei materiali utilizzati come il cristallo nero e l'acciaio laccato con finiture in maiolica. L'innovativo sistema di accesso al serbatoio, attraverso lo scorrimento del coperchio superiore, garantisce un elegante e raffinato design. Ideale per chi vuole distribuire il calore in ambienti diversi e riscaldare più locali, basta un semplice gesto per gestire il flusso dell'aria verso le canalizzazioni. Due canalizzazioni, indipendenti l'una dall'altra con la possibilità di gestire entrambi i flussi separatamente con la massima flessibilità. Dotata del pratico scaldavivande in maiolica, igienico e di facile pulizia.
- DEU Dorica Supreme, Feuersäule mit einer modellierten und mäßigen Linien, dank auf die benutzte Materiale wie die schwarze Glass und lackiertem Stahl mit Oberflächen in Majolika. Das innovative System für den Zugang zum Tank, durch die obere Abdeckung, bietet eine elegante und raffinierte Design. Ideal für diejenigen, die Wärme in verschiedenen Umgebungen verteilt möchten, um sie zu heizen, nur eine einfache Geste, um das Strömen von Luft in den Kanalisierungen zu verwalten. Zwei Kanalisierungs, unabhängig voneinander, mit der Möglichkeit, die Ströme in unabhängiger Weise zu verwalten und mit der maximalen Flexibilität. Ausgestattet mit einer hygienischen Warmhaltefläche aus Majolika, einfach zu reinigen.
- ENG Dorica Supreme, column of fire, classical line carved by the strength of raw materials, black glass and painted steel with finishes in majolica. The innovative sliding top access to the fuel tank enhances its many other attractive features. If you would like a ducted hot air supply into several rooms the Dorica Plus provides an ideal solution. It is possible to warm different spaces quickly and easily via an intuitive control system designed to distribute hot air into the ducting system. The twin air ducting system is designed to provide independent outlets which are both able to share air the flow with maximum flexibility. Equipped with the practical, hygienic and easy to clean hot plate in majolica.
- FRA Dorica Supreme, colonne de feu à la ligne sobre et sculptée, grâce à l'alternance des matériaux utilisés, comme le cristal noir ou l'acier laqué avec finitions en majolica. Idéal pour qui désire distribuer l'air chaud dans des pièces différentes et réchauffer divers locaux. Un simple geste suffit pour adresser le flux de l'air vers les canalisations. Deux canalisations indépendantes, pour avoir la possibilité de gérer les flux indépendamment et avec la plus grande flexibilité. Doté d'un chauffe-plats coulissant en majolica, pratique, hygiénique et simple à nettoyer.
- ESP Dorica Supreme, columna de fuego de línea sobria y esculpida con alternancia de materiales: cristal negro y acero pintado con acabados en majólica. Ideal para quien quiere distribuir el calor en varias habitaciones; de manera muy sencilla permite gestionar el flujo de aire a través de la canalización. Dos canalizaciones, independientes la una de la otra con posibilidad de gestionar los flujos de aire con la máxima flexibilidad. Equipada con un práctico plano para calentar comidas hecho en majólica higiénica y fácil de limpiar.

Uscite per canalizzazione disponibili:
due posteriori
Duct vents options: two rear



• Thermocomfort (optional)
Radiocomando con termostato ambiente;
Funksteuerung mit Raumthermostat;
Radio control with room thermostat;
Radiocommande avec thermostat d'ambiance;
Radio control con termostato de ambiente;

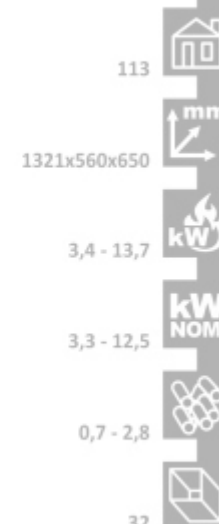
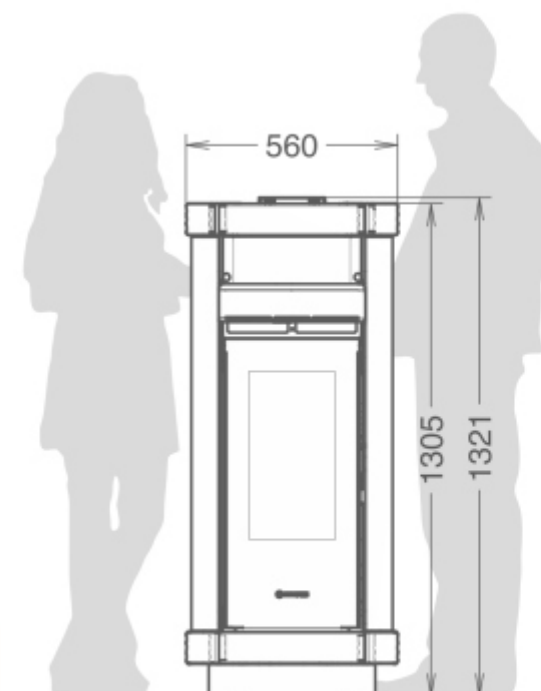

16m³
8m³x2



DORICA supreme maiolica

- ITA Dorica Supreme, colonna di fuoco dalla linea sobria e scolpita grazie all'alternanza dei materiali utilizzati come il cristallo nero e la maiolica. L'innovativo sistema di accesso al serbatoio, attraverso lo scorrimento del coperchio superiore, garantisce un elegante e raffinato design. Ideale per chi vuole distribuire il calore in ambienti diversi e riscaldare più locali, basta un semplice gesto per gestire il flusso dell'aria verso le canalizzazioni. Due canalizzazioni, indipendenti l'una dall'altra con la possibilità di gestire entrambi i flussi separatamente con la massima flessibilità. Dotata del pratico scaldavivande in maiolica, igienico e di facile pulizia.
- DEU Dorica Supreme, Feuersäule mit einer modellierten und mäßigen Linien, dankte auf die benutzte Materiale wie die schwarze Glass und Steingut. Das innovative System für den Zugang zum Tank, durch die obere Abdeckung, bietet eine elegante und raffinierte Design. Ideal für diejenigen, die die Wärme in verschiedenen Umgebungen verteilt möchten, um sie zu heizen, nur eine einfache Geste, um das Strömen von Luft in den Kanalisierungen zu verwalten. Zwei Kanalisierungen, unabhängig voneinander, mit der Möglichkeit, die Ströme in unabhängiger Weise zu verwalten und mit der maximalen Flexibilität. Ausgestattet mit einer hygienischen Warmhaltefläche aus Majolica, einfach zu reinigen.
- ENG Dorica Supreme, column of fire, classical line carved by the strength of raw materials, black glass and majolica. The innovative sliding top access to the fuel tank enhances its many other attractive features. If you would like a ducted hot air supply into several rooms the Dorica Plus provides an ideal solution. It is possible to warm different spaces quickly and easily via an intuitive control system designed to distribute hot air into the ducting system. The twin air ducting system is designed to provide independent outlets which are both able to share air the flow with maximum flexibility. Equipped with the practical, hygienic and easy to clean hot plate in majolica.
- FRA Dorica Supreme, colonne de feu à la ligne sobre et sculptée, grâce à l'alternance des matériaux utilisés, comme le cristal noir ou la céramique. Idéal pour qui désire distribuer l'air chaud dans des pièces différentes et réchauffer divers locaux. Un simple geste suffit pour adresser le flux de l'air vers les canalisations. Deux canalisations indépendantes, pour avoir la possibilité de gérer les flux indépendamment et avec la plus grande flexibilité. Doté d'un chauffe-plats en majolica, pratique, hygiénique et simple à nettoyer.
- ESP Dorica Supreme, columna de fuego de línea sobria y esculpida con alternancia de materiales: cristal negro y cerámica. Ideal para quien quiere distribuir el calor en varias habitaciones; de manera muy sencilla permite gestionar el flujo de aire a través de la canalización. Dos canalizaciones, independientes la una de la otra con posibilidad de gestionar los flujos de aire con la máxima flexibilidad. Equipada con un práctico plano para calentar comidas hecho en majolica higiénica y fácil de limpiar.

Uscite per canalizzazione disponibili:
due posteriori
Duct vents options: two rear

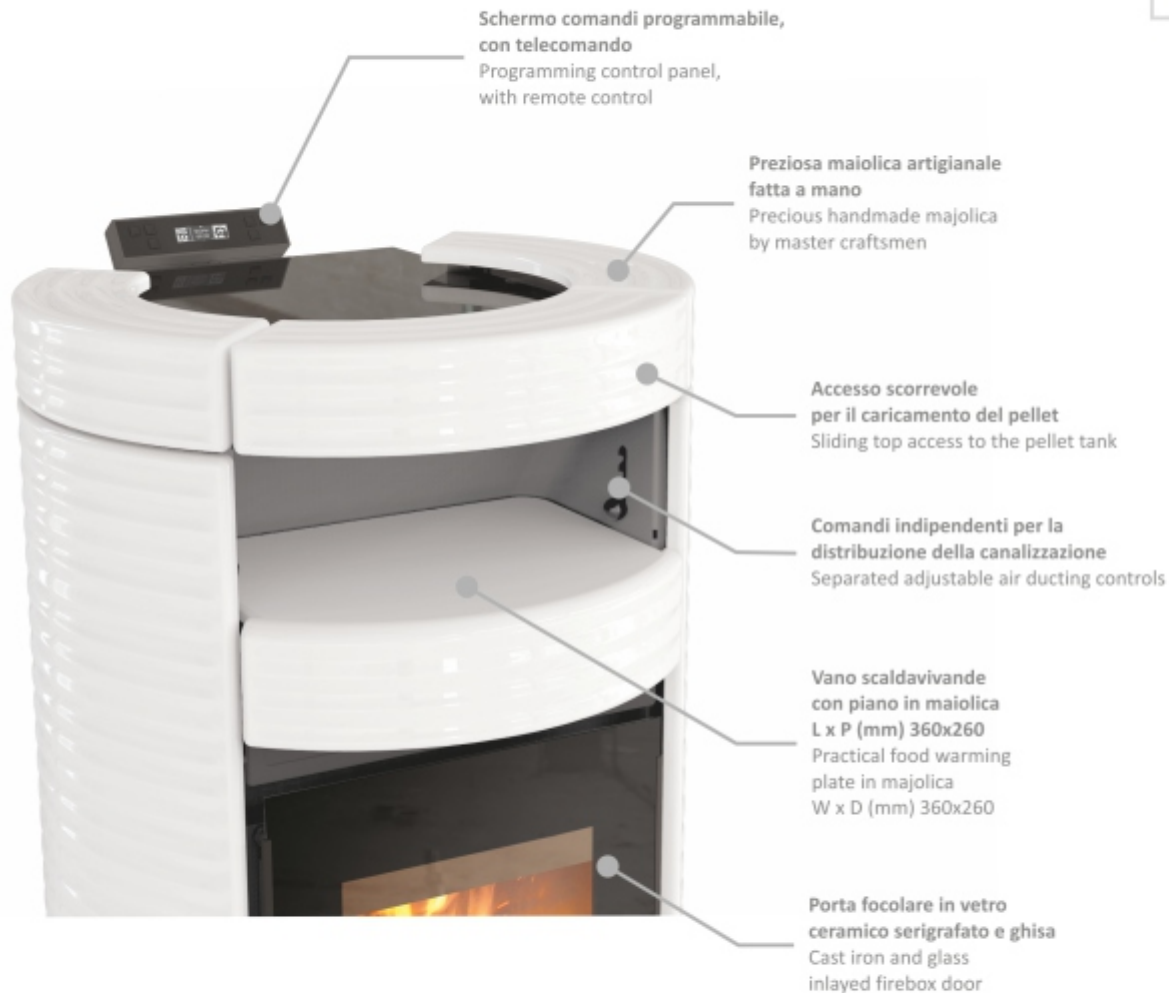

Schermo comandi programmabile,
con telecomando
Programming control panel,
with remote control

Preziosa maiolica artigianale
fatta a mano
Precious handmade majolica
by master craftsmen

Accesso scorrevole
per il caricamento del pellet
Sliding top access to the pellet tank

Comandi indipendenti per la
distribuzione della canalizzazione
Separated adjustable air ducting controls

Vano scaldavivande
con piano in maiolica
L x P (mm) 360x260
Practical food warming
plate in majolica
W x D (mm) 360x260

Porta focolare in vetro
ceramico serigrafato e ghisa
Cast iron and glass
inlaid firebox door



• Thermocomfort (optional)
Radiocomando con termostato ambiente;
Funksteuerung mit Raumthermostat;
Radio control with room thermostat;
Radiocommande avec thermostat d'ambiance;
Radio control con termostato de ambiente;

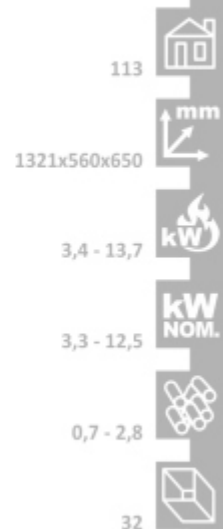
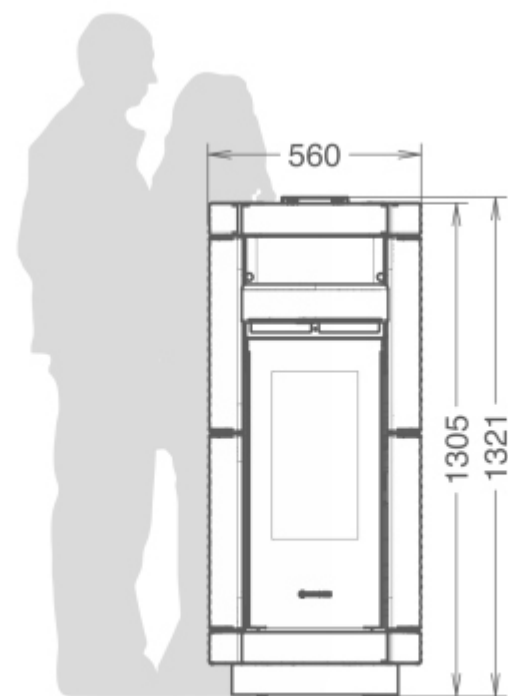

16m^x1
8m^x2



SAINT MORITZ supreme

- ITA Raffinata eleganza in stile romantico per tutti coloro che amano circondarsi da preziosi complementi d'arredo, Saint Moritz Supreme rappresenta la massima espressione di cura del dettaglio, dalle preziose maioliche lavorate a mano al pratico vano scaldavivande. Ideale per chi vuole distribuire il calore in ambienti diversi e riscaldare più locali, basta un semplice gesto per gestire il flusso dell'aria verso le canalizzazioni. Due canalizzazioni, indipendenti l'una dall'altra con la possibilità di gestire entrambi i flussi separatamente con la massima flessibilità. Pulizia straordinaria e ordinaria semplificata con tecnologia EASY CLEANING.
- DEU Raffinierte Eleganz gepaart mit romantischem Stil, so präsentiert sich dieser Pelletofen all jenen, die sich gerne mit edlen Objekten umgeben. Saint Moritz Supreme ist der ultimative Ausdruck von Aufmerksamkeit bis ins kleinste Detail. Der Ofen ist mit einer hygienischen Warmhaltefläche, einfach zu reinigen ausgestattet. Ideal für diejenigen, die die Wärme in verschiedenen Umgebungen verteilt möchten, um sie zu heizen, nur eine einfache Geste, um das Strömen von Luft in den Kanalisierungen zu verwalten. Zwei Kanalisierungs, unabhängig voneinander, mit der Möglichkeit, die Ströme in unabhängiger Weise zu verwalten und mit der maximalen Flexibilität. Ordentliche und außerordentliche Reinigung leichter mit EASY CLEANING System.
- ENG Refined elegance in a romantic style, for all those who love to surround themselves with precious furnishings. Saint Moritz Supreme is the ultimate expression of attention to detail, from precious handmade majolica to the practical food warmer. If you would like a ducted hot air supply into several rooms, Saint Moritz Supreme provides an ideal solution. It is possible to warm different spaces quickly and easily via an intuitive control system designed to distribute hot air into the ducting system. The twin air ducting system is designed to provide independent outlets which are both able to share air the flow with maximum flexibility. Equipped with simplified cleaning system EASY CLEANING.
- FRA Éléance raffinée en style romantique, pour qui aime s'entourer d'objets précieux. Saint Moritz Supreme représente la plus grande expression dans le soin du détail. Doté d'un chauffe-plats, pratique, hygiénique et simple à nettoyer. Idéal pour qui désire distribuer l'air chaud dans des pièces différentes et réchauffer divers locaux. Un simple geste suffit pour adresser le flux de l'air vers les canalisations. Deux canalisations indépendantes, pour avoir la possibilité de gérer les flux indépendamment et avec la plus grande flexibilité. Doté du système de nettoyage ordinaire et extraordinaire simplifié EASY CLEANING.
- ESP Elegancia refinada en un estilo romantico, para todos los que aman rodearse con muebles preciosos, Saint Moritz Supreme es la máxima expresión de la atención al detalle, desde la preciosa majolica hasta el práctico hueco para calentar comidas. Ideal para quien quiere distribuir el calor en varias habitaciones; de manera muy sencilla permite gestionar el flujo de aire a través de la canalización. Dos canalizaciones, independientes la una de la otra con posibilidad de gestionar los flujos de aire con la máxima flexibilidad. Limpiezas ordinarias y extraordinarias simplificadas EASY CLEANING.

Uscite per canalizzazione disponibili:
due posteriori
Duct vents options: two rear



• Thermocomfort (optional)
Radiocomando con termostato ambiente;
Funksteuerung mit Raumthermostat;
Radio control with room thermostat;
Radiocommande avec thermostat d'ambiance;
Radio control con termostato de ambiente;

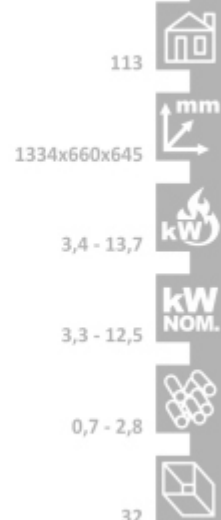
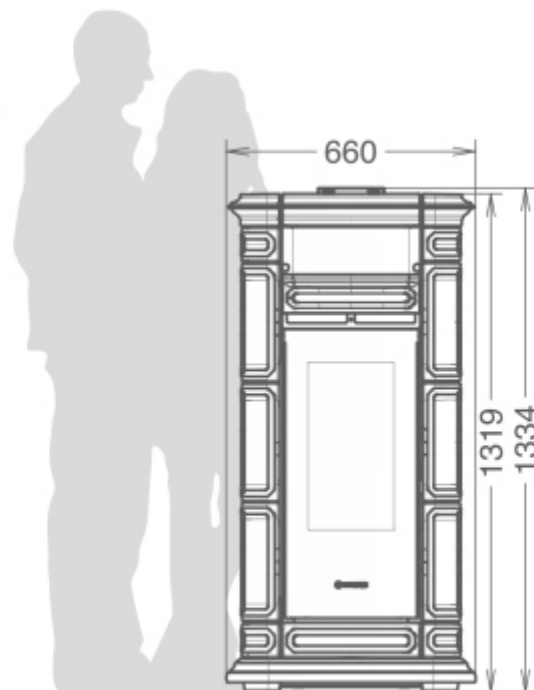

16m^x1
8m^x2



DORICA[®] supreme idra metalcolor

- ITA Dorica Supreme, colonna di fuoco dalla linea sobria e scolpita grazie all'alternanza dei materiali utilizzati come il cristallo nero e la maiolica. L'innovativo sistema di accesso al serbatoio, attraverso lo scorrimento del coperchio superiore, garantisce un elegante e raffinato design. Il design Dorica[®] Supreme si arricchisce nella versione idra con un nuovo modello ancora più potente. Ideale per il riscaldamento domestico diventa il cuore dell'impianto. L'innovativo bruciatore motorizzato con tecnologia brevettata PELLETPOWER[®] mantiene la resa termica elevata e costante nell'arco dell'intera giornata: mantenere il bruciatore pulito significa ridurre sia la manutenzione ordinaria che i costi di combustibile, con un rapido ammortamento del generatore.
- DEU Dorica Supreme mit Majolikakacheln ist eine Feuersäule welche dank seiner klassisch gerillten Form und einer Schwarzglasfront überzeugt. Das innovative Befüllungssystem des Pellettanks mittels Schiebemechanismus verbindet eine einfache Pelletbefüllung mit elegantem und raffiniertem Design. Die Dorica[®] Familie, wird nun mit einem neuen wassergeführten Modell erweitert, welches noch leistungsfähiger ist. Wenn Sie eine größere Fläche durch eine Pellet-Heizung erwärmen möchten, bietet dieses Produkt die ideale Lösung. Es bildet den Kern des Heizsystems welches dank seiner kompakten Abmessungen einfach im Wohnbereich integriert werden kann. PELLETPOWER[®] das innovative patentierte Brennersystem hält den Sauerstoffgehalt bei der Verbrennung konstant und hält die Effizienz der Verbrennung für einen langen Zeitraum stabil. Der Brenner wird konstant saubergehalten und somit reduzieren sich die Brennstoffkosten und die Amortisation des Heizgerätes über viele Jahre.
- ENG Dorica[®] Supreme, column of fire, classically shaped by the power of the raw materials, black glass and majolica. The innovative sliding top access to the fuel tank enhances its many other attractive features. The Dorica[®] designed collection enhances itself with the entry of a new idra version. If you would like to heat domestic environment through a pellet-heating generator, it provides the ideal solution and it becomes the core of the system. The PELLETPOWER[®] innovative patented burner maintains the correct rate of oxygen keeping the efficiency of combustion stable for longer periods; keeping the burner clean means reducing cleaning times and fuel costs, and payback initial heating-generator costs over few years.
- FRA Dorica Supreme, colonne de feu à la ligne sobre et sculptée, grâce à l'alternance des matériaux utilisés, comme le cristal noir et la céramique. L'innovant système d'accès au réservoir à granulés par coulissement du couvercle supérieur garantit un design élégant et raffiné. Le très design Dorica[®] Supreme s'enrichit dans sa version idra d'un nouveau modèle encore plus puissant. Idéal pour le chauffage domestique, il devient le cœur du circuit. L'innovant brûleur motorisé avec technologie brevetée PELLETPOWER[®] maintient le rendement thermique élevé et constant tout au long du jour : garder le brûleur propre signifie réduire aussi bien la manutention ordinaire que les frais de combustible, avec un amortissement plus rapide du générateur.
- ESP Dorica Supreme, columna de fuego de línea sobria y esculpida gracias a la alternancia de materiales: cristal negro y cerámica. El Design Dorica[®] Supreme se enriquece en la versión idra con un nuevo modelo, aún más potente. Ideal para la calefacción del hogar, se convierte en el centro de la instalación integrándose fácilmente gracias a sus opciones tecnológicas. El quemador motorizado con tecnología patentada PELLETPOWER[®] mantiene constantemente una alta eficiencia térmica durante todo el día: mantener limpio el quemador quiere decir reducir tanto el mantenimiento como los gastos de combustible, con una rápida amortización del generador.



PELLETPOWER®
bruciatore brevettato



• **INTEGRA TR-PACK (optional)**
Thermocell® (250/400/500 lt);
Thermopuffer (400/500 lt);
Thermosole® (2.0 e 2.6);



• **Valvola termostatica a 3 vie**
1" FFF 55 OT (optional);
Thermostatic valve 3 ways
1" FFF 55 OT (optional);
Vanne thermostatique 3 voies
1" FFF 55 OT (optional);



• **Sonda PT100 (optional - min 2 pz)**
per funzione «THERMOCONTROL»;
PT100 sensor (optional - min 2 pc)
for «THERMOCONTROL» function;
Sonde PT100 (optional - min 2 pces)
pour fonction «THERMOCONTROL»;

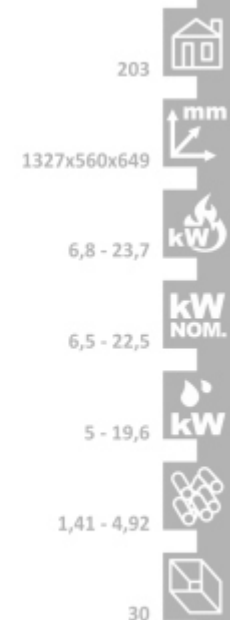
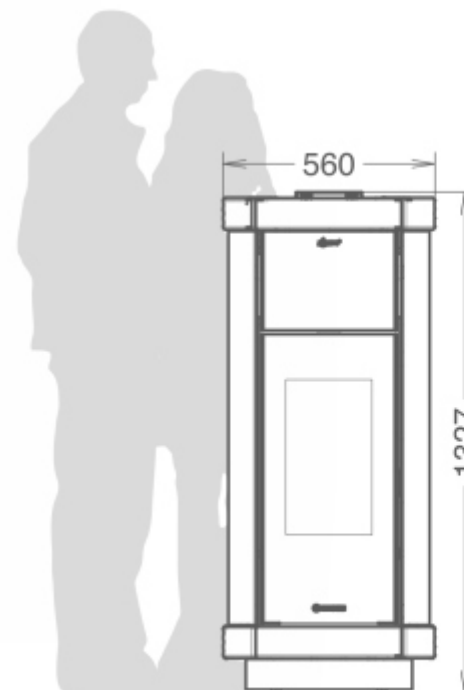



DORICA[®] supreme idra maiolica

- ITA** Dorica Supreme, colonna di fuoco dalla linea sobria e scolpita grazie all'alternanza dei materiali utilizzati come il cristallo nero e la maiolica. L'innovativo sistema di accesso al serbatoio, attraverso lo scorrimento del coperchio superiore, garantisce un elegante e raffinato design. Il design Dorica[®] Supreme si arricchisce nella versione idra con un nuovo modello ancora più potente, ideale per il riscaldamento domestico diventa il cuore dell'impianto. L'innovativo bruciatore motorizzato con tecnologia brevettata PELLETPOWER[®] mantiene la resa termica elevata e costante nell'arco dell'intera giornata: mantenere il bruciatore pulito significa ridurre sia la manutenzione ordinaria che i costi di combustibile, con un rapido ammortamento del generatore.
- DEU** Dorica Supreme mit Majolikakacheln ist eine Feuersäule welche dank seiner klassisch gerillten Form und einer Schwarzglasfront überzeugt. Das innovative Befüllungssystem des Pellettanks mittels Schiebemechanismus verbindet eine einfache Pelletbefüllung mit elegantem und raffiniertem Design. Die Dorica[®] Familie, wird nun mit einem neuen wassergeführten Modell erweitert, welches noch leistungsfähiger ist. Wenn Sie eine größere Fläche durch eine Pellet-Heizung erwärmen möchten, bietet dieses Produkt die ideale Lösung. Es bildet den Kern des Heizsystems welches dank seiner kompakten Abmessungen einfach im Wohnbereich integriert werden kann. PELLETPOWER[®] das innovative patentierte Brennersystem hält den Sauerstoffgehalt bei der Verbrennung konstant und hält die Effizienz der Verbrennung für einen langen Zeitraum stabil. Der Brenner wird konstant saubergehalten und somit reduzieren sich die Brennstoffkosten und die Amortisation des Heizgerätes über viele Jahre.
- ENG** Dorica[®] Supreme, column of fire, classically shaped by the power of the raw materials, black glass and majolica. The innovative sliding top access to the fuel tank enhances its many other attractive features. The Dorica[®] designed collection enhances itself with the entry of a new idra version. If you would like to heat domestic environment through a pellet-heating generator, it provides the ideal solution and it becomes the core of the system. The PELLETPOWER[®] innovative patented burner maintains the correct rate of oxygen keeping the efficiency of combustion stable for longer periods: keeping the burner clean means reducing cleaning times and fuel costs, and payback initial heating-generator costs over few years.
- FRA** Dorica Supreme, colonne de feu à la ligne sobre et sculptée, grâce à l'alternance des matériaux utilisés, comme le cristal noir et la céramique. L'innovant système d'accès au réservoir à granulés par coulissement du couvercle supérieur garantit un design élégant et raffiné. Le très design Dorica[®] Supreme s'enrichit dans sa version idra d'un nouveau modèle encore plus puissant. Idéal pour le chauffage domestique, il devient le cœur du circuit. L'innovant brûleur motorisé avec technologie brevetée PELLETPOWER[®] maintient le rendement thermique élevé et constant tout au long du jour : garder le brûleur propre signifie réduire aussi bien la manutention ordinaire que les frais de combustible, avec un amortissement plus rapide du générateur.
- ESP** Dorica Supreme, columna de fuego de línea sobria y esculpida gracias a la alternancia de materiales: cristal negro y cerámica. El Design Dorica[®] Supreme se enriquece en la versión idra con un nuevo modelo, aún más potente. Ideal para la calefacción del hogar, se convierte en el centro de la instalación integrándose fácilmente gracias a sus opciones tecnológicas. El quemador motorizado con tecnología patentada PELLETPOWER[®] mantiene constantemente una alta eficiencia térmica durante todo el día: mantener limpio el quemador quiere decir reducir tanto el mantenimiento como los gastos de combustible, con una rápida amortización del generador.



Piano igienico, in cristallo
Plate in hygienic glass

Accesso scorrevole per
il caricamento del pellet
Sliding top access
to the pellet tank

Preziosa maiolica artigianale
fatta a mano
Precious handmade majolica
by master craftsmen

Porta focolare in vetro
ceramico serigrafato e ghisa
Cast iron and glass
inlaid firebox door

Bruciatore brevettato
Pelletpower®
PelletPower®
patented burner

Piano salva cenere in maiolica
Ash collecting base in majolica



• INTEGRA TR-PACK (optional)
Thermocell® (250/400/500 lt);
Thermopuffer (400/500 lt);
Thermosole® (2.0 e 2.6);



• Valvola termostatica a 3 vie
1" FFF 55 OT (optional);
Thermostatic valve 3 ways
1" FFF 55 OT (optional);
Vanne thermostatique 3 voies
1" FFF 55 OT (optional);



• Sonda PT100 (optional - min 2 pz)
per funzione «THERMOCONTROL»;
PT100 sensor (optional - min 2 pc)
for «THERMOCONTROL» function;
Sonde PT100 (optional - min 2 pces)
pour fonction «THERMOCONTROL»;

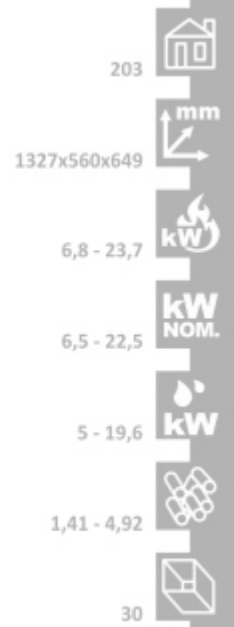
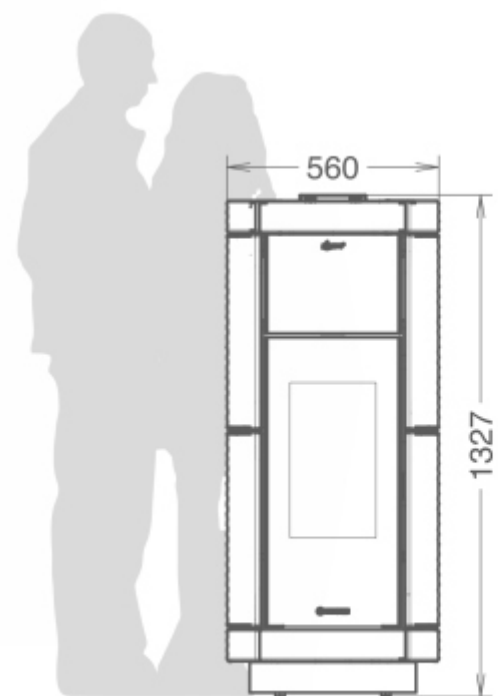



SAINT MORITZ supreme idra

- ITA** Raffinata eleganza in stile romantico per tutti coloro che amano circondarsi da preziosi complementi d'arredo, Saint Moritz® Supreme diventa da oggi disponibile nella versione Idra. Questa termostufa rappresenta la massima espressione di cura del dettaglio, dalle preziose maioliche lavorate a mano all'innovativo bruciatore motorizzato con tecnologia PELLETPOWER®. Grazie all'efficiente scambiatore di calore THERMOCORE®, formato da un fascio tubiero dotato di turbolatori e grazie al funzionamento automatico con modulazione di potenza, Saint Moritz® Idra Supreme ottiene un rendimento superiore al 90%. La robustezza del corpo caldaia, la silenziosità, la facilità di gestione, la pulizia semplificata e le basse emissioni fanno della gamma Idra una soluzione alternativa ed ecologica al tradizionale sistema di riscaldamento domestico.
- DEU** Raffinierte Eleganz gepaart mit romantischem Stil, so präsentiert sich dieser Pelletofen all jenen, die sich gerne mit edlen Objekten umgeben. St. Moritz Supreme ist jetzt auch in wassergeführter Version erhältlich. Dieser Wärmeerzeuger stellt den maximalen Ausdruck der Liebe zum Detail dar. Von der kostbaren handgefertigten Majolika bis zum innovativen PELLETPOWER® patentierten Brenner. Dank des hocheffizienten THERMOCORE Rohrwärmetauschers, erhöht sich die Wärmetauscher Fläche und führt zu einem Wirkungsgrad von mehr als 90%. Die stabile Struktur des Kessels, der Ruhige Betrieb und die einfache Art und Weise das Produkt zu reinigen gepaart mit den niedrigen Emissionen machen den Ofen zu einer ökologischen und praktikablen Alternative zu konventionellen Heizsystemen.
- ENG** Refined elegance in romantic style, for all those who love to surround themselves with precious furnishings. Saint Moritz Supreme is now available also in the Idra version. This heating generator represents the maximum expression of attention to detail, from the precious majolica handmade by master craftsmen to the PELLETPOWER® innovative patented burner. Thanks to the high efficient vertical pipes heat exchanger THERMOCORE, that increases the exchange surface, Saint Moritz® Idra Supreme performs an efficiency of more than 90%. The stability of the structure of the boiler, the silence, the easier way to maintain and clean it and its very low emissions make the idra collection the alternative and ecological solution to conventional heating systems.
- FRA** Élégance raffinée en style romantique pour qui aime s'entourer de meubles précieux. Le Saint Moritz® Supreme est aujourd'hui disponible dans la version Idra. Ce thermo-poêle représente la plus grande expression de l'attention au détail, des précieuses céramiques faites à la main à l'innovant brûleur motorisé avec technologie brevetée PELLETPOWER®. Grâce à son efficient échangeur de chaleur THERMOCORE® formé d'un faisceau tubulaire doté de turbulateurs, et grâce à son fonctionnement automatique avec modulation de puissance, le Saint Moritz® Idra Supreme obtient un rendement supérieur à 90%. La robustesse du corps de chaudière, le silence de fonctionnement, la facilité de gestion, le nettoyage simplifié, et les basses émissions, font de la gamme Idra une solution alternative et écologique au système de chauffage domestique traditionnel.
- ESP** Refinada elegancia en un estilo romántico, dedicada a los que les gusta rodearse de elementos de decoración, San Moritz® Supreme ahora está disponible en versión Hydra. Este generador representa la máxima expresión de la atención al detalle, desde la preciosa mayólica hecha a mano hasta el quemador motorizado patentado con la tecnología PELLETPOWER®. Gracias al eficiente intercambiador de calor THERMOCORE®, formado a partir de un haz de tubos equipados con turbuladores, y gracias a la operación en automático con modulación de potencia, San Moritz® Hydra Supreme consigue un rendimiento superior al 90%. La robustez del cuerpo de la caldera, el poco ruido, la facilidad de gestión, la limpieza simplificada y las bajas emisiones destacan la gama Hydra como primera solución alternativa y ecológica al sistema de calefacción tradicional de cada vivienda.

Schermo comandi programmabile, con telecomando

Programming control panel, with remote control

Piano igienico in cristallo

Hygienic glass plate

Accesso scorrevole per il caricamento del pellet

Sliding top access to the pellet tank

Preziosa maiolica artigianale fatta a mano

Precious handmade majolica by master craftsmen

Porta focolare in vetro ceramico serigrafato e ghisa

Cast iron and glass inlaid firebox door



• INTEGRA TR-PACK (optional)
Thermocell® (250/400/500 lt);
Thermopuffer (400/500 lt);
Thermosole® (2.0 e 2.6);



• Valvola termostatica a 3 vie
1" FFF 55 OT (optional);
Thermostatic valve 3 ways
1" FFF 55 OT (optional);
Vanne thermostatique 3 voies
1" FFF 55 OT (optional);



• Sonda PT100 (optional - min 2 pz)
per funzione «THERMOCONTROL»;
PT100 sensor (optional - min 2 pc)
for «THERMOCONTROL» function;
Sonde PT100 (optional - min 2 pces)
pour fonction «THERMOCONTROL»;

Bianco



Beige



Tortora



Bordeaux



203



1335x660x630



6,8 - 23,7



6,5 - 22,5



5 - 19,6



1,41 - 4,92



30



PELLETPOWER
bruciatore brevettato

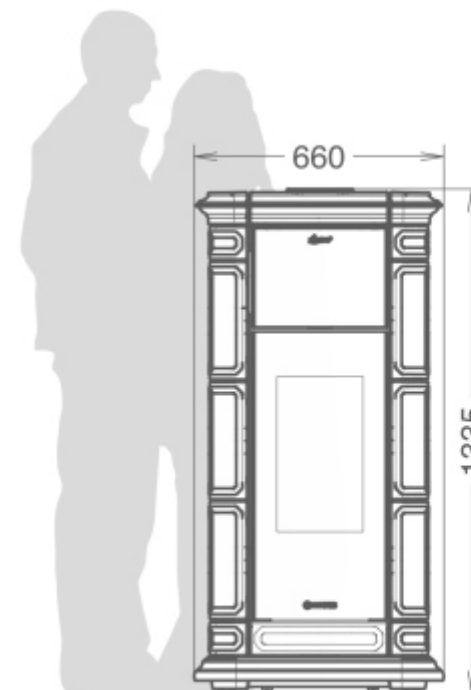



7000 e H₂O 18 maiolica

- ITA Disponibile in diverse finiture, diventa protagonista della vostra casa; è dotata di scambiatore di calore THERMOCORE® e pulizia straordinaria e ordinaria semplificata con tecnologia EASY CLEANING. Un pratico selettore permette di regolare il calore dal frontale al retro e riscaldare così altri ambienti nella versione plus (7000). Dotata di bruciatore motorizzato con tecnologia PELLETPOWER® nella versione Idra (H₂O), capace di contenere e scambiare un ottimale volume d'acqua è perfettamente collegabile ad un impianto termoidraulico di una intera abitazione.
- DEU Mit mehreren Oberflächen erhältlicher Pelletöfen, der zum Dreh- und Angelpunkt Ihres Zuhauses wird. Mehr Effizienz und Energieeinsparung dank den Wärmetauscher in vertikalen Röhren THERMOCORE® und ordentliche und außerordentliche Reinigung leichter mit EASY CLEANING System. Mit einem praktischen Wählschalter läßt sich die Wärme von der Vorderseite auf die Rückseite umregeln, um auch andere Räume zu beheizen in Version Plus (7000). Version Idra (H₂O) ist mit dem PELLETPOWER® Patentierter Brenner ausgestattet.
- ENG Pellet heater available in a variety of finishes, will become a stunning centerpiece for your home. The innovative design of the vertical tube heat exchanger THERMOCORE® allows the appliance to achieve both a very high performance and maximum energy saving. Equipped with simplified cleaning system EASY CLEANING. A practical selector allows you to adjust the heat from the front to the back and consequently to heat more than one room in Plus version (7000). Idra version (H₂O) is equipped with the PELLETPOWER® technology patented burner.
- FRA Disponible en différentes finitions devient protagoniste de votre maison. Grand rendement et économie d'énergie grâce à l'échangeur à tubes vertical THERMOCORE®. Doté du système de nettoyage ordinaire et extraordinaire simplifié EASY CLEANING. Un sélecteur pratique permet de régler la chaleur de l'avant à l'arrière et de chauffer ainsi d'autres milieux en version Plus (7000). Doté du brûleur motorisé avec technologie PELLETPOWER® in version Idra (H₂O).
- ESP Disponible con diversos acabados, que se convierte en protagonista de la casa. Gran eficiencia y ahorro energético gracias al intercambiador a tubos verticales THERMOCORE®. Limpiezas ordinarias y extraordinarias simplificadas EASY CLEANING. Un práctico selector permite regular el calor desde la parte frontal hasta la posterior, pudiendo así calentar otras habitaciones en versión Plus (7000). Equipada con la tecnología de quemador motorizado PELLETPOWER® in versión Idra (H₂O).



8000 Inox

- ITA** Autonomia fino a 60 ore, vetro autopulente, facile pulizia, cassetto cenere di notevoli dimensioni sono le principali caratteristiche che vi sorprenderanno nell'utilizzo di 8000. E' dotata di scambiatore di calore THERMOCORE® e pulizia ordinaria e straordinaria semplificata con tecnologia EASY CLEANING, di serie cassetto cenere estraibile.
- DEU** Brenndauer bis zu 60 Stunden, einfache Wartung, selbstreinigendes Glas, große Aschenlade sind die entscheidenden Vorteile, die Sie beim Heizen mit 8000 genießen werden. Mehr Effizienz und Energieeinsparung dank den Wärmetauscher in vertikalen Röhren THERMOCORE® und ordentliche und außerordentliche Reinigung leichter mit EASY CLEANING System, herausnehmbaren Swerienaschekasten.
- ENG** Up to 60 continuous running hours available on one fill of fuel, self-cleaning glass, easy maintenance and a large ash drawer are the extraordinary features which will surprise you when using 8000. The innovative design of the vertical tube heat exchanger THERMOCORE® allows the appliance to achieve both a very high performance and maximum energy saving. Equipped with simplified cleaning system EASY CLEANING and with removable ash pan as standard.
- FRA** Autonomie jusqu'à 60 heures, vitre autonettoyante, nettoyage simple, tiroir cendres de grandes dimensions, sont les caractéristiques principales qui vous étonneront dans l'utilisation de 8000. Grand rendement et économie d'énergie grâce à l'échangeur à tubes vertical THERMOCORE®. Doté du système de nettoyage ordinaire et extraordinaire simplifié EASY CLEANING, avec tiroir des cendres extractible de série.
- ESP** Autonomía hasta 60 horas, cristal autolimpiable, limpieza fácil, cajón para la ceniza de grande tamaño son las características principales que os sorprenderán utilizando 8000. Gran eficiencia y ahorro energético gracias al intercambiador a tubos verticales THERMOCORE®. Limpiezas ordinarias y extraordinarias simplificadas EASY CLEANING, de serie cajón de cenizas extraíble.



Schermo comandi programmabile, con telecomando
Programming control panel, with remote control

Preziosa maiolica artigianale fatta a mano
Precious handmade majolica by master craftsmen

Vano scaldavivande con piano in maiolica*
Practical food warming plate in majolica*

Porta focolare in ghisa con vetro ceramico curvo
Cast iron firebox door with curved ceramic glass



• Thermocomfort (optional)
Radiocomando con termostato ambiente;
Funksteuerung mit Raumthermostat;
Radio control with room thermostat;
Radiocommande avec thermostat d'ambiance;
Radio control con termostato de ambiente;

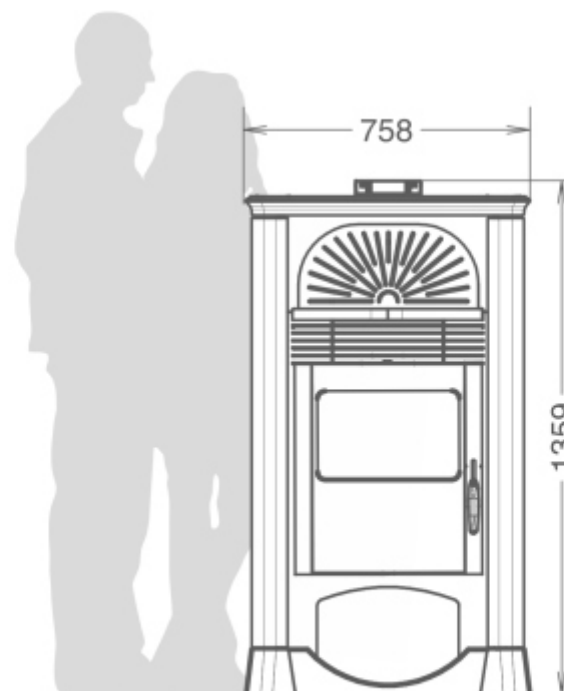

- 97
- 1359x758x638
- 5,6 - 12,4
- 4,8 - 10,8
- 1,2 - 2,6
- 53

Maiolica

Bianco

Beige

Bordeaux

Nero

Metalcolor

Beige

Bordeaux

Grigio

Maiolica nera e Inox

Nero



* Solo versione Maiolica
* Only on Maiolica version

H₂O 25 e 34 metalcolor

ITA Sviluppa una maggiore potenza termica con rendimenti superiori al 90% e bassissime emissioni, progettata e costruita per soddisfare il fabbisogno di calore e benessere nelle Vostre abitazioni. Grande efficienza e risparmio energetico grazie allo scambiatore a tubi verticale THERMOCORE®, porta focolare e braciere in ghisa pesante, dotata di bruciatore motorizzato con tecnologia PELLETPOWER®. Pulizia straordinaria e ordinaria straordinaria semplificata con tecnologia EASY CLEANING.

DEU Er entwickelt eine höhere Heizleistung mit Wirkungsgraden von mehr als 90% und einem äußerst geringen Schadstoffausstoß, ein mit Pellet befeuerter Heizofen, der so konstruiert und gebaut ist, dass er den Heizbedarf Ihrer Wohnung deckt und Wohlbefinden garantiert. Mehr Effizienz und Energieeinsparung dank den Wärmetauscher in vertikalen Röhren THERMOCORE®, Brennkammer, Tür des Feuerraum und Brenntopf in Gusseseisen, ausgestattet mit dem PELLETPOWER® Patentierter Brenner. Ordentliche und außerordentliche Reinigung leichter mit EASY CLEANING System.

ENG It develops greater thermal power output, providing efficiency exceeding 90% and low exhaust emissions, designed and built to meet the heating and comfort requirements of your home. The innovative design of the vertical tube heat exchanger THERMOCORE® allows the appliance to achieve both a very high performance and maximum energy saving. The front door and the pellet burning pot, constructed in heavy cast iron, add an extra degree of reliability and longevity. Equipped with the PELLETPOWER® technology patented burner and with simplified cleaning system EASY CLEANING.

FRA Produit une plus grande puissance thermique, avec des rendements supérieurs à 90% et très peu d'émissions, conçu et construit pour satisfaire le besoin de chaleur et le bien-être de vos maisons. Grand rendement et économie d'énergie grâce à l'échangeur à tubes vertical THERMOCORE® et à la chambre de combustion, la porte du foyer et le brasero en fonte épaisse. Doté du brûleur motorisé avec technologie PELLETPOWER® et du système de nettoyage ordinaire et extraordinaire simplifié EASY CLEANING.

ESP H2O desarrolla mayor potencia térmica, con rendimientos superiores al 90% y emisiones sumamente bajas: una estufa de pellet diseñada y construida para satisfacer la necesidad de calor y bienestar de su hogar. Gran eficiencia y ahorro energético gracias al intercambiador a tubos verticales THERMOCORE®. Cámara de combustión, puerta y quemador en fundición de alta calidad. Equipada con la tecnología de quemador motorizado PELLETPOWER®. Limpiezas ordinarias y extraordinarias simplificadas EASY CLEANING.



IONICA metalcolor idra 28

ITA Ionica Idra fa parte della gamma di colonne di fuoco realizzate per soddisfare il fabbisogno di calore e benessere con particolare attenzione al design, è dotata di bruciatore motorizzato con tecnologia PELLETPOWER®, scambiatore di calore THERMOCORE® e pulizia ordinaria e straordinaria semplificata EASY CLEANING.

DEU Der Ionica Idra gehört zu einer Produktgruppe, welche für größeren Wärmebedarf und maximales Wohlbefinden, mit dem Fokus am Design des Pelletofens, entwickelt wurde. Ausgestattet mit der PELLETPOWER® Technologie, dem Wärmetauscher THERMOCORE® und dem einfachen EASY CLEANING Reinigungssystem.

ENG Ionica Hydro belongs to a range of fire columns designed to meet the needs of warmth and well-being with a focus on design. Equipped with the motorised fan technology PELLETPOWER® (hydro model) heat exchanger THERMOCORE® and simplified cleaning system EASY CLEANING.

FRA Le Ionica Idra fait partie de la gamme des colonnes de feu, réalisée pour satisfaire le besoin de chaleur et bien-être, mais avec une attention particulière au design. Doté du brûleur motorisé avec technologie PELLETPOWER®, de l'échangeur de chaleur THERMOCORE®, et du système de nettoyage ordinaire et extraordinaire simplifié EASY CLEANING.

ESP Ionica Idra pertenece a la gama de "columnas de fuego" diseñada para satisfacer las necesidades de calor y bienestar con un enfoque en el diseño. Equipada con la tecnología de quemador motorizado PELLETPOWER®, intercambiador de calor THERMOCORE® y limpieza ordinaria y extraordinaria simplificadas EASY CLEANING.



Maniglia removibile.
Essenzialità nel design
e maggior sicurezza
Removable door handle.
Essential design
and high safety

Porta focolare in vetro
ceramico serigrafato e
ghisa
Cast iron and glass
firebox door

Brucciatoe brevettato
PelletPower®
PelletPower®
patented burner

Preziosa maiolica artigianale
fatta a mano
Precious handmade majolica
by master craftsmen

Piano salva cenere
Ash collecting base



• INTEGRA TR-PACK (optional)
Thermocell® (250/400/500 lt);
Thermopuffer (400/500 lt);
Thermosole® (2.0 e 2.6);



• Valvola termostatica a 3 vie
1" FFF 55 OT (optional);
Thermostatic valve 3 ways
1" FFF 55 OT (optional);
Vanne thermostatique 3 voies
1" FFF 55 OT (optional);



• Sonda PT100 (optional - min 2 pz)
per funzione «THERMOCONTROL»;
PT100 sensor (optional - min 2 pc)
for «THERMOCONTROL» function;
Sonde PT100 (optional - min 2 pces)
pour fonction «THERMOCONTROL»;

- Bianco
- Beige
- Tortora
- Bordeaux
- Grigio

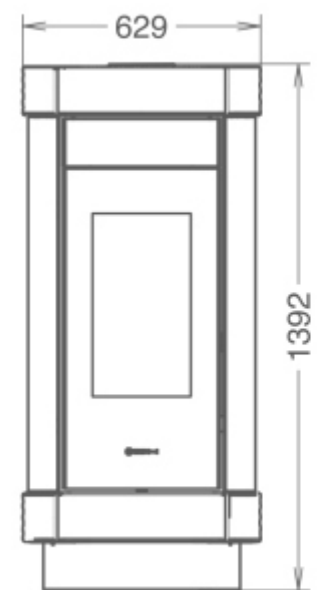

- 231
- mm
- 1392x629x700
- 6,9 - 28
- 6,4 - 25,7
- 5,8 - 24,7
- 1,5 - 6,1
- 40



PELLETPOWER®
bruciatore brevettato





IONICA maiolica idra 28

ITA Ionica Idra fa parte della gamma di colonne di fuoco realizzate per soddisfare il fabbisogno di calore e benessere con particolare attenzione al design, è dotata di bruciatore motorizzato con tecnologia PELLETPOWER®, scambiatore di calore THERMOCORE® e pulizia ordinaria e straordinaria semplificata EASY CLEANING.

DEU Der Ionica Idra gehört zu einer Produktgruppe, welche für größeren Wärmebedarf und maximales Wohlbefinden, mit dem Fokus am Design des Pelletofens, entwickelt wurde. Ausgestattet mit der PELLETPOWER® Technologie, dem Wärmetauscher THERMOCORE® und dem einfachen EASY CLEANING Reinigungssystem.

ENG Ionica Hydro belongs to a range of fire columns designed to meet the needs of warmth and well-being with a focus on design. Equipped with the motorised fan technology PELLETPOWER® (hydro model) heat exchanger THERMOCORE® and simplified cleaning system EASY CLEANING.

FRA Le Ionica Idra fait partie de la gamme des colonnes de feu, réalisée pour satisfaire le besoin de chaleur et bien-être, mais avec une attention particulière au design. Doté du brûleur motorisé avec technologie PELLETPOWER®, de l'échangeur de chaleur THERMOCORE®, et du système de nettoyage ordinaire et extraordinaire simplifié EASY CLEANING.

ESP Ionica Idra pertenece a la gama de "columnas de fuego" diseñada para satisfacer las necesidades de calor y bienestar con un enfoque en el diseño. Equipada con la tecnología de quemador motorizado PELLETPOWER®, Intercambiador de calor THERMOCORE® y limpieza ordinaria y extraordinaria simplificadas EASY CLEANING.

Schermo comandi programmabile
Programming control panel

Accesso scorrevole
per il caricamento del pellet
Sliding top access to the pellet tank

Preziosa maiolica artigianale
fatta a mano
Precious handmade majolica
by master craftsmen

Porta focolare in vetro
ceramico serigrafato e ghisa
Precious cast iron and glass
firebox door

Maniglia removibile.
Essenzialità nel design
e maggior sicurezza
Removable door handle.
Essential design
and high safety



• INTEGRA TR-PACK (optional)
Thermocell® (250/400/500 lt);
Thermopuffer (400/500 lt);
Thermosole® (2.0 e 2.6);



• Valvola termostatica a 3 vie
1" FFF 55 OT (optional);
Thermostatic valve 3 ways
1" FFF 55 OT (optional);
Vanne thermostatique 3 voies
1" FFF 55 OT (optional);



• Sonda PT100 (optional - min 2 pz)
per funzione «THERMOCONTROL»;
PT100 sensor (optional - min 2 pc)
for «THERMOCONTROL» function;
Sonde PT100 (optional - min 2 pces)
pour fonction «THERMOCONTROL»;

Bianco

Beige

Tortora

Bordeaux

Nero



231



1392x629x700



6,9 - 28



6,4 - 25,7



5,8 - 24,7



1,5 - 6,1



40



PELLETPower
bruciatore brevettato

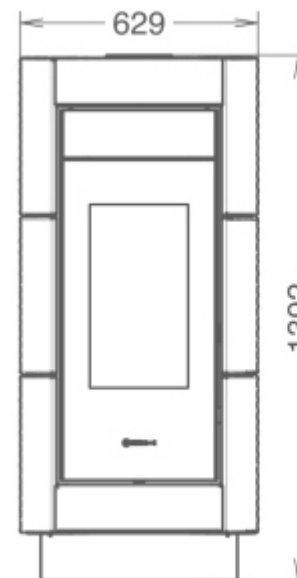

LEGENDA

ZEICHENERKLÄRUNG

LEGEND
LEGENDE
LEYENDA



[mm] Misure (HxLxP)
[mm] Abmessungen (HxBxT)
[mm] Dimensions (HxWxD)
[mm] Dimensions (HxLxP)
[mm] Dimensiones (AxAxP)



[kW] Potenza al focolare (min/max) (a)
[kW] Feuerraumleistung (min/max) (a)
[kW] Power to the hearth (min/max) (a)
[kW] Puissance au foyer (min/max) (a)
[kW] Energia al hogar (min/max) (a)



[kW] Potenza nominale (min/max) (a)
[kW] Nennleistung (min/max) (a)
[kW] Rated power (min/max) (a)
[kW] Puissance nominale (min/max) (a)
[kW] Potencia nominal (min/max) (a)



[kW] Potenza all'acqua (a)
[kW] Leistung ans Wasser (a)
[kW] Power to the water (a)
[kW] Puissance à l'eau (a)
[kW] Energia al agua (a)



[kg] Capacità serbatoio pellet (a)
[kg] Fassungsvermögen Pelletsbehälter (a)
[kg] Pellet hopper capacity (a)
[kg] Capacité du réservoir des pellets (a)
[kg] Cabida tanque de pellets (a)



[kg/h] Consumo orario pellet (min/max) (a)
[kg/h] Stündlicher pelletsverbrauch (min/max) (a)
[kg/h] Hourly pellet consumption (min/max) (a)
[kg/h] Consommation horaire pellets (min/max) (a)
[kg/h] Consumo horario pellets (min/max) (a)



[m²] Area riscaldabile (a)(b)
[m²] Beheizte Fläche (a)(b)
[m²] Heatable area (a)(b)
[m²] Chauffez jusqu'à (a)(b)
[m²] Zona calentable (a)(b)

(a) Il dato varia in base al tipo di pellet utilizzato. I valori sono stati rilevati utilizzando pellet omologato secondo normativa EN 14961-2A1-A2.

(a) Die Daten hängen von der Art des verwendeten Pellets ab. Die Werte wurden mit zugelassenen Pellets Gesetzgebung erhoben EN 14961-2A1-A2.

(a) Values can change on the basis of the pellet used. These results were obtained using certified pellet according to EN 14961-2 A1-A2.

(a) La valeur peut changer suivant le type de granulés de bois utilisé. Toutes les données sont enregistrées en utilisant des granulés homologués conformément aux normes EN 14961-2 A1-A2.

(a) El dato declarado puede variar segundo el tipo de pellet utilizado. Estos valores se obtuvieron utilizando pellet certificado por la normativa EN 14961-2A1-A2.

(b) È importante tenere in considerazione che il volume riscaldabile dipende in modo considerevole dall'isolamento dell'abitazione (classe energetica), dal posizionamento nella planimetria e dalla zona climatica quindi i valori indicati possono variare anche considerevolmente.

(Coefficiente di scambio termico = 37 W/m²)

(b) Es ist wichtig zu bedenken, dass die beheizbare Fläche von der Hausisolierung (Energienstufe), von der Positionierung des Ofens im Haus und von der klimatischen Region deutlich abhängt. Die angegebenen Werte können dann auch beträchtlich variieren. (Wärmeübergangskoeffizient = 37 W/m²)

(b) It is very important to consider that the potential volume to heat is strictly linked to the insulation of the house (energetic class), to the plan of the building and to the climatic area, so these results may differ more or less according to these aspects.

(Heat transfer coefficient = 37 W/m²)

(b) Il faut considérer que le volume pouvant être réchauffé dépend énormément de l'isolation de l'habitation (classe énergétique), de la disposition des pièces et de la zone climatique. Ces valeurs peuvent donc varier considérablement.

(Coefficiente de transfert thermique = 37 W/m²)

(b) Es muy importante considerar que el volumen calentable depende mucho del aislamiento de la vivienda (clase energética), del plano estructural y de la zona climática, de consecuencia los valores indicados pueden variar en manera considerable.

(Coeficiente de película = 37 W/m²)

La ditta costruttrice si riserva di apportare modifiche senza preavviso.

Der Hersteller behält sich das Recht vor, Änderungen ohne vorherige Ankündigung vorzunehmen.

The manufacturer reserves the right to make changes without previous notice.

Le fabricant se réserve d'apporter des modifications sans préavis.

El productor se reserva el derecho de aportar modificaciones sin preaviso.

THERMOROSSI ^{tr}

Fire Lovers

Seguici su:
Find us on:



YouTube



facebook



Pinterest



Instagram

THERMOROSSI S.p.A.
Via Grumolo, 4 (Z.I.)
36011 Arsiero (VI) - ITALY
www.thermorossi.com
info@thermorossi.it



Numero Verde
800-448877

Per conoscere il punto
vendita a voi più vicino.

Worldwide - Phone: 0039.0445.741310 - e-mail: export@thermorossi.it